

UCC2751x Single-Channel, High-Speed, Low-Side Gate Driver (Based On CMOS Input Threshold With 4-A Peak Source and 4-A Peak Sink)

1 Features

- Low-Cost, Gate-Driver Device Offering Superior Replacement of NPN and PNP Discrete Solutions
- Pin-to-Pin Compatible With TI's [TPS2828](#) and [TPS2829](#) devices
- 4-A Peak Source and 4-A Peak Sink Symmetrical Drive
- Fast Propagation Delays (17-ns Typical)
- Fast Rise and Fall Times (8-ns and 7-ns Typical)
- 4.5-V to 18-V Single Supply Range
- Outputs Held Low During VDD UVLO (Ensures Glitch-Free Operation at Power Up and Power Down)
- CMOS Input Logic Threshold (Function of Supply Voltage With Hysteresis)
- Hysteretic Logic Thresholds for High Noise Immunity
- EN Pin for Enable Function (Allowed to Be No Connect)
- Output Held Low when Input Pins are Floating
- Input Pin Absolute Maximum Voltage Levels Not Restricted by VDD Pin Bias Supply Voltage
- Operating Temperature Range of -40°C to 140°C
- 5-Pin DBV Package (SOT-23)

2 Applications

- Switched-Mode Power Supplies
- DC-DC Converters
- Companion Gate Driver Devices for Digital Power Controllers
- Solar Power, Motor Control, UPS
- Gate Driver for Emerging Wide Band-Gap Power Devices (Such as GaN)

3 Description

The UCC27518 and UCC27519 single-channel, high-speed, low-side gate driver device can effectively drive MOSFET and IGBT power switches. Using a design that inherently minimizes shoot-through current, UCC27518 and UCC27519 can source and sink high, peak-current pulses into capacitive loads offering rail-to-rail drive capability and extremely small propagation delay typically 17 ns.

The UCC27518 and UCC27519 provide 4-A source, 4-A sink (symmetrical drive) peak-drive current capability at $V_{DD} = 12\text{ V}$.

The UCC27518 and UCC27519 are designed to operate over a wide VDD range of 4.5 V to 18 V and a wide temperature range of -40°C to 140°C . Internal under voltage lockout (UVLO) circuitry on the VDD pin holds output low outside VDD operating range. The capability to operate at low voltage levels such as below 5 V, along with best-in-class switching characteristics, is especially suited for driving emerging wide band-gap power switching devices such as GaN power semiconductor devices.

Device Information⁽¹⁾

| PART NUMBER | PACKAGE | BODY SIZE (NOM) |
|-------------|------------|-------------------|
| UCC27518 | SOT-23 (5) | 2.90 mm x 1.60 mm |
| UCC27519 | | |

(1) For all available packages, see the orderable addendum at the end of the datasheet.

Typical Application Diagram

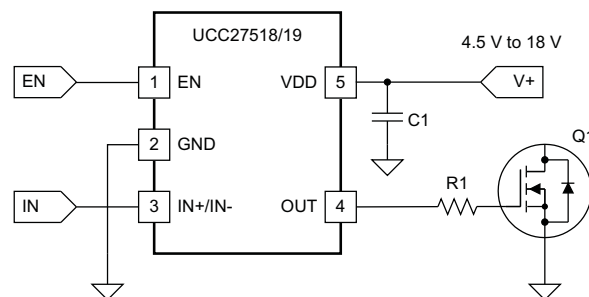

Table of Contents

| | | | |
|--|-----------|--|-----------|
| 1 Features | 1 | 9.3 Feature Description..... | 14 |
| 2 Applications | 1 | 9.4 Device Functional Modes..... | 17 |
| 3 Description | 1 | 10 Application and Implementation | 18 |
| 4 Revision History | 2 | 10.1 Application Information..... | 18 |
| 5 Description (continued) | 3 | 10.2 Typical Application | 18 |
| 6 Device Comparison Table | 3 | 11 Power Supply Recommendations | 22 |
| 7 Pin Configuration and Functions | 4 | 12 Layout | 22 |
| 8 Specifications | 5 | 12.1 Layout Guidelines | 22 |
| 8.1 Absolute Maximum Ratings | 5 | 12.2 Layout Example | 23 |
| 8.2 ESD Ratings..... | 5 | 12.3 Thermal Considerations..... | 23 |
| 8.3 Recommended Operating Conditions..... | 5 | 12.4 Power Dissipation | 24 |
| 8.4 Thermal Information | 5 | 13 Device and Documentation Support | 25 |
| 8.5 Electrical Characteristics..... | 6 | 13.1 Related Links | 25 |
| 8.6 Switching Characteristics | 7 | 13.2 Trademarks | 25 |
| 8.7 Typical Characteristics..... | 10 | 13.3 Electrostatic Discharge Caution..... | 25 |
| 9 Detailed Description | 13 | 13.4 Glossary | 25 |
| 9.1 Overview | 13 | 14 Mechanical, Packaging, and Orderable Information | 25 |
| 9.2 Functional Block Diagrams | 14 | | |

4 Revision History

Changes from Original (May 2012) to Revision A

Page

- Added *Pin Configuration and Functions* section, *ESD Ratings* table, *Feature Description* section, *Device Functional Modes*, *Application and Implementation* section, *Power Supply Recommendations* section, *Layout* section, *Device and Documentation Support* section, and *Mechanical, Packaging, and Orderable Information* section **1**

5 Description (continued)

The input pin threshold of the UCC27518 and UCC27519 are based on CMOS logic where the threshold voltage is a function of the V_{DD} supply voltage. Typically Input High Threshold (V_{IN-H}) is 55% V_{DD} and Input Low Threshold (V_{IN-L}) is 39% V_{DD}. Wide hysteresis (16% V_{DD} typically) between the high and low thresholds offers excellent noise immunity and lets users introduce delays using RC circuits between the input PWM signal and the IN_x pin of the device.

The UCC27518 and UCC27519 also feature a floatable enable function on the EN pin. The EN pin can be left in a no connect condition, which allows pin-to-pin compatibility between the UCC27518, UCC27519 and the TPS2828, TPS2829, respectively. The thresholds of the EN pin is a fixed voltage threshold and does not vary based on V_{DD} pin bias voltage. Typically, the Enable High Threshold (V_{EN-H}) is 2.1 V and Enable Low Threshold (V_{EN-L}) is 1.25 V.

6 Device Comparison Table

The UCC2751x family of gate driver products (Table 1) represent TI's latest generation of single-channel, low-side high-speed gate driver devices featuring high-source/sink current capability, industry best-in-class switching characteristics and a host of other features (Table 2) all of which combine to ensure efficient, robust and reliable operation in high-frequency switching power circuits.

Table 1. UCC2751x Product Family Summary

| PART NUMBER | PACKAGE | PEAK CURRENT (SOURCE/SINK) | INPUT THRESHOLD LOGIC |
|----------------------------|-------------------------|---------------------------------|--|
| UCC27511DBV ⁽¹⁾ | SOT-23, 6 pin | 4-A/8-A (Asymmetrical Drive) | CMOS/TTL-Compatible (low voltage, independent of V _{DD} bias voltage) |
| UCC27512DRS ⁽¹⁾ | 3 mm x 3 mm WSON, 6 pin | | |
| UCC27516DRS ⁽¹⁾ | 3 mm x 3 mm WSON, 6 pin | 4-A/4-A (Symmetrical Drive) | CMOS (follows V _{DD} bias voltage) |
| UCC27517DBV ⁽¹⁾ | SOT-23, 5 pin | | |
| UCC27518DBV | SOT-23, 5 pin | | |
| UCC27519DBV | SOT-23, 5 pin | | |

(1) Visit www.ti.com for the latest product datasheet.

7 Pin Configuration and Functions

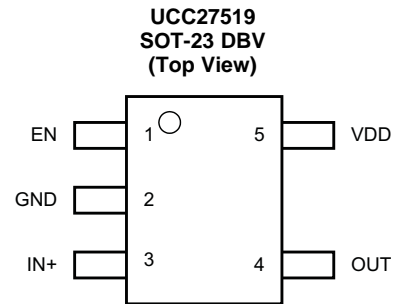
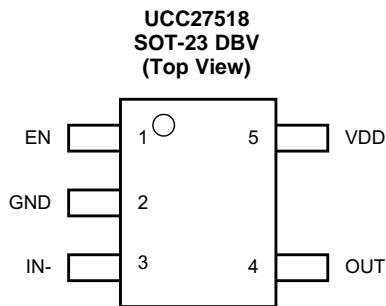

Pin Functions

| PIN | | I/O | DESCRIPTION |
|-----|------|-----|---|
| NO. | NAME | | |
| 1 | EN | I | Enable input: (EN biased LOW disables output regardless of Input state, EN biased high or floating enables output, EN is allowed to float hence it is pin-to-pin compatible with TPS282X N/C pin) |
| 2 | GND | — | Ground: All signals referenced to this pin |
| 3 | IN– | I | Input: Inverting input in the UCC27518, output held LOW if IN– is unbiased or floating |
| | IN+ | I | Input: Noninverting input in the UCC27519, output held LOW if IN+ is unbiased or floating |
| 4 | OUT | O | Sourcing and sinking current output of driver |
| 5 | VDD | I | Supply input |

8 Specifications

8.1 Absolute Maximum Ratings⁽¹⁾⁽²⁾⁽³⁾

over operating free-air temperature range (unless otherwise noted)

| | | MIN | MAX | UNIT |
|--|---------------------------------------|------|-----------|------|
| Supply voltage | VDD | -0.3 | 20 | V |
| OUT voltage | | -0.3 | VDD + 0.3 | |
| Output continuous current | I _{OUT_DC} (source/sink) | | 0.3 | A |
| Output pulsed current (0.5 μs) | I _{OUT_pulsed} (source/sink) | | 4 | |
| IN+, IN- ⁽⁴⁾ , EN | | -0.3 | 20 | V |
| Operating virtual junction temperature, T _J | | -40 | 150 | °C |
| Lead temperature | Soldering, 10 sec. | | 300 | |
| | Reflow | | 260 | |
| Storage temperature, T _{stg} | | -65 | 150 | |

- (1) Stresses beyond those listed under Absolute Maximum Ratings may cause permanent damage to the device. These are stress ratings only and functional operation of the device at these or any other conditions beyond those indicated under [Recommended Operating Conditions](#) is not implied. Exposure to absolute-maximum-rated conditions for extended periods may affect device reliability.
- (2) All voltages are with respect to GND unless otherwise noted. Currents are positive into, negative out of the specified terminal. See Packaging Section of the data sheet for thermal limitations and considerations of packages.
- (3) These devices are sensitive to electrostatic discharge; follow proper device handling procedures.
- (4) Maximum voltage on input pins is not restricted by the voltage on the VDD pin.

8.2 ESD Ratings

| | | VALUE | UNIT |
|--|--|-------|------|
| V _(ESD) Electrostatic discharge | Human body model (HBM), per ANSI/ESDA/JEDEC JS-001 ⁽¹⁾ | ±4000 | V |
| | Charged-device model (CDM), per JEDEC specification JESD22-C101 ⁽²⁾ | ±1000 | |

- (1) JEDEC document JEP155 states that 500-V HBM allows safe manufacturing with a standard ESD control process.
- (2) JEDEC document JEP157 states that 250-V CDM allows safe manufacturing with a standard ESD control process.

8.3 Recommended Operating Conditions

over operating free-air temperature range (unless otherwise noted)

| | | MIN | NOM | MAX | UNIT |
|--|--|-----|-----|-----|------|
| Supply voltage range, VDD | | 4.5 | 12 | 18 | V |
| Operating junction temperature range | | -40 | | 140 | °C |
| Input voltage, (IN+ and IN-) and Enable (EN) | | 0 | | 18 | V |

8.4 Thermal Information

| THERMAL METRIC | | UCC27518 | UCC27519 | UNIT |
|-----------------------|---|------------|---------------------------|------|
| | | SOT-23 DBV | SOT-23 DBV ⁽¹⁾ | |
| | | 5 PINS | 5 PINS | |
| R _{θJA} | Junction-to-ambient thermal resistance ⁽¹⁾ | 217.6 | 217.6 | °C/W |
| R _{θJC(top)} | Junction-to-case (top) thermal resistance ⁽¹⁾ | 85.8 | 85.8 | |
| R _{θJB} | Junction-to-board thermal resistance ⁽¹⁾ | 44.0 | 44.0 | |
| ψ _{JT} | Junction-to-top characterization parameter ⁽¹⁾ | 4.0 | 4.0 | |
| ψ _{JB} | Junction-to-board characterization parameter ⁽¹⁾ | 43.2 | 43.2 | |

- (1) For more information about traditional and new thermal metrics, see the *IC Package Thermal Metrics* application report, [SPRA953](#).

8.5 Electrical Characteristics

VDD = 12 V, T_A = T_J = -40 °C to 140 °C, 1-μF capacitor from VDD to GND. Currents are positive into, negative out of the specified terminal.

| PARAMETER | | TEST CONDITIONS | MIN | TYP | MAX | UNIT | |
|------------------------------------|--|--|---|-------|------|------|----|
| BIAS CURRENTS | | | | | | | |
| I _{DD(off)} | Startup current | VDD = 3.4 V | IN+ = VDD (UCC27519), IN- = GND (UCC27518) | 51 | 85 | 123 | μA |
| | | | IN+ = GND (UCC27519), IN- = VDD (UCC27518) | 51 | 70 | 103 | |
| UNDERVOLTAGE LOCKOUT (UVLO) | | | | | | | |
| V _{ON} | Supply start threshold | T _A = 25 °C | 3.85 | 4.20 | 4.57 | V | |
| | | T _A = -40 °C to 140°C | 3.80 | 4.20 | 4.67 | | |
| V _{OFF} | Minimum operating voltage after supply start | | 3.45 | 3.9 | 4.35 | | |
| V _{DD_H} | Supply voltage hysteresis | | 0.19 | 0.3 | 0.45 | | |
| INPUTS (IN+, IN-) | | | | | | | |
| V _{IN_H} | Input signal high threshold | VDD = 4.5 V | | 55 | 62 | %VDD | |
| V _{IN_L} | Input signal low threshold | | 31 | 39 | | | |
| V _{IN_HYS} | Input signal hysteresis | | | 16 | | | |
| V _{IN_H} | Input signal high threshold | VDD = 12 V | | 55 | 59 | | |
| V _{IN_L} | Input signal low threshold | | 31 | 39 | | | |
| V _{IN_HYS} | Input signal hysteresis | | | 16 | | | |
| V _{IN_H} | Input signal high threshold | VDD = 18 V | | 55 | 58 | | |
| V _{IN_L} | Input signal low threshold | | 35 | 38 | | | |
| V _{IN_HYS} | Input signal hysteresis | | | 17 | | | |
| ENABLE (EN) | | | | | | | |
| V _{EN_H} | Enable signal high threshold | VDD = 12 V | | 2.1 | 2.3 | V | |
| V _{EN_L} | Enable signal low threshold | | 1.00 | 1.25 | | | |
| V _{EN_HYS} | Enable hysteresis | | | 0.86 | | | |
| SOURCE/SINK CURRENT | | | | | | | |
| I _{SRC/SNK} | Source/sink peak current ⁽¹⁾ | C _{LOAD} = 0.22 μF, F _{SW} = 1 kHz | | -4/+4 | | A | |
| OUTPUTS (OUT) | | | | | | | |
| V _{DD} -V _{OH} | High output voltage | VDD = 12 V I _{OUT} = -10 mA | | 50 | 90 | mV | |
| | | VDD = 4.5 V I _{OUT} = -10 mA | | 60 | 130 | | |
| V _{OL} | Low output voltage | VDD = 12 V I _{OUT} = 10 mA | | 5 | 11 | | |
| | | VDD = 4.5 V I _{OUT} = 10 mA | | 6 | 12 | | |
| R _{OH} | Output pullup resistance ⁽²⁾ | VDD = 12 V I _{OUT} = -10 mA | | 5.0 | 7.5 | Ω | |
| | | VDD = 4.5 V I _{OUT} = -10 mA | | 5.0 | 11.0 | | |
| R _{OL} | Output pulldown resistance | VDD = 12 V I _{OUT} = 10 mA | | 0.5 | 1.0 | | |
| | | VDD = 4.5 V I _{OUT} = 10 mA | | 0.6 | 1.2 | | |

(1) Ensured by Design.

(2) R_{OH} represents on-resistance of P-Channel MOSFET in pullup structure of the UCC27518 and UCC27519's output stage.

8.6 Switching Characteristics

over operating free-air temperature range (unless otherwise noted)

| PARAMETER | TEST CONDITIONS | MIN | TYP | MAX | UNIT |
|---|--|-----|-----|-----|------|
| t_R Rise time ⁽¹⁾ | $C_{LOAD} = 1.8 \text{ nF}$ | | 8 | 12 | ns |
| t_F Fall time ⁽¹⁾ | $C_{LOAD} = 1.8 \text{ nF}$ | | 7 | 11 | |
| t_{D1} IN+ to output propagation delay ⁽¹⁾ | VDD = 10 V 7-V input pulse, $C_{LOAD} = 1.8 \text{ nF}$ | 6 | 17 | 25 | |
| t_{D2} IN- to output propagation delay ⁽¹⁾ | VDD = 10 V 7-V input pulse, $C_{LOAD} = 1.8 \text{ nF}$ | 6 | 17 | 24 | |
| t_{D3} EN to output high propagation delay ⁽¹⁾ | $C_{LOAD} = 1.8 \text{ nF}$, 5-V enable pulse | 4 | 12 | 16 | |
| t_{D4} EN to output low propagation delay ⁽¹⁾ | $C_{LOAD} = 1.8 \text{ nF}$, 5-V enable pulse | 4 | 12 | 19 | |

(1) See timing diagrams in [Figure 1](#), [Figure 2](#), [Figure 3](#), and [Figure 4](#).

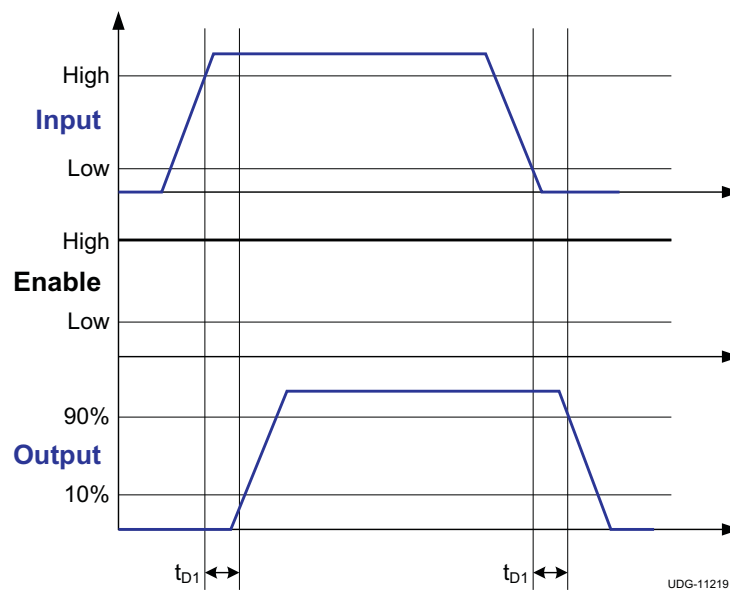

(In+ Pin, UCC27519)

Figure 1. Noninverting Configuration

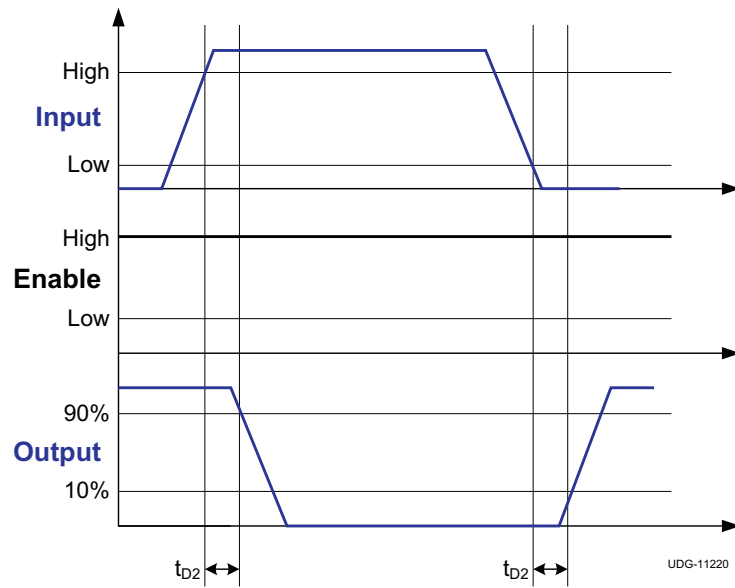

(In- Pin, UCC27518)

Figure 2. Inverting Configuration

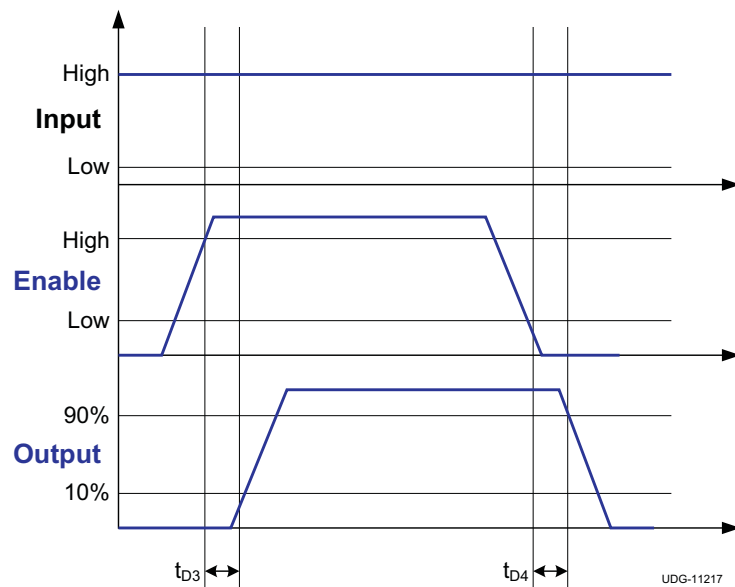

(Noninverting Configuration, UCC27519)

Figure 3. Enable and Disable Function

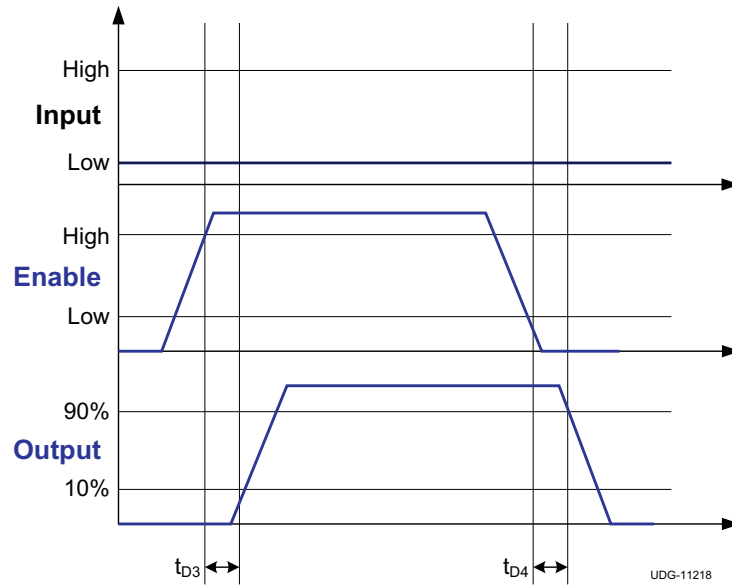

(Inverting Configuration, UCC27518)

Figure 4. Enable and Disable Function

8.7 Typical Characteristics

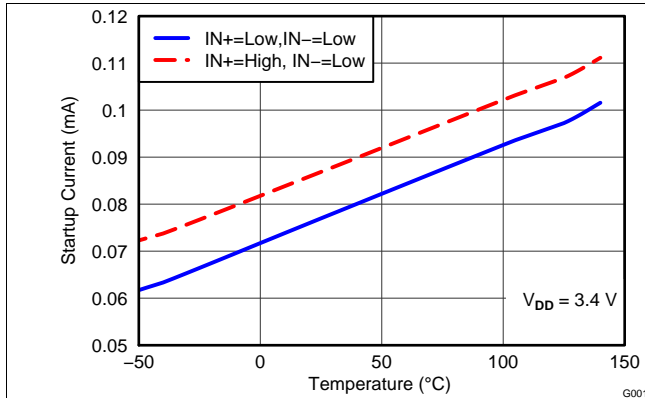

Figure 5. Start-Up Current vs Temperature

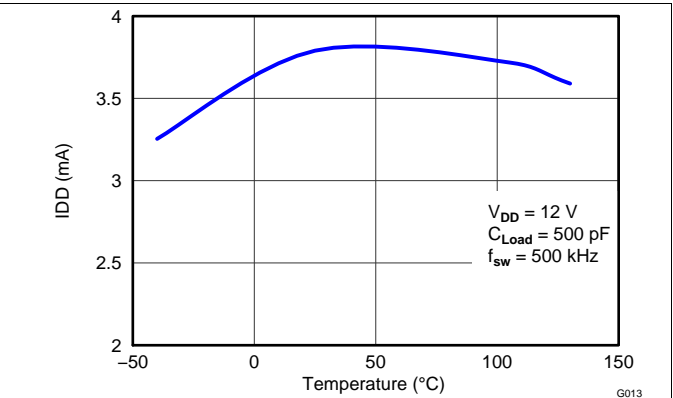

Figure 6. Operating Supply Current vs Temperature (Output Switching)

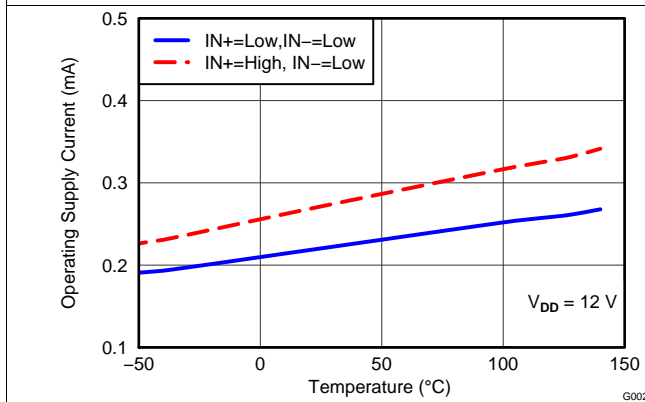

Figure 7. Supply Current vs Temperature (Output in DC On/Off Condition)

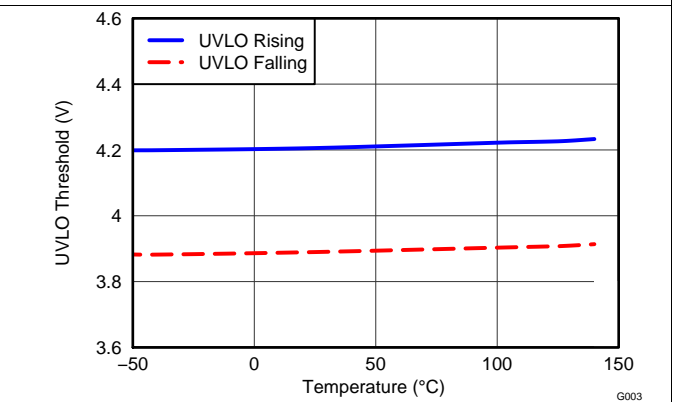

Figure 8. UVLO Threshold Voltage vs Temperature

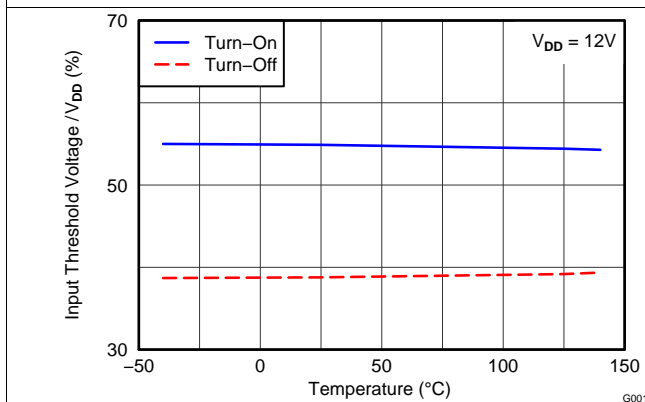

Figure 9. Input Threshold vs Temperature

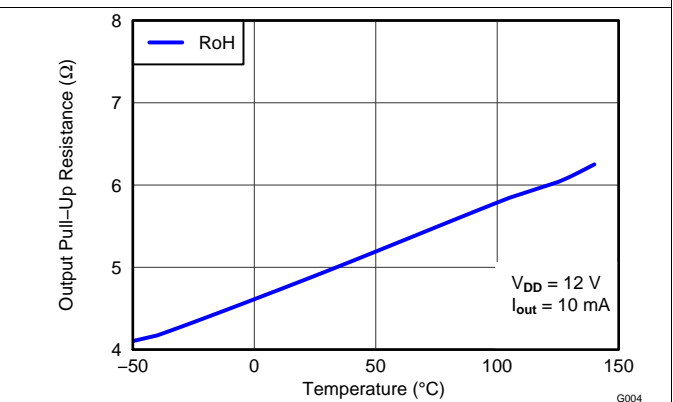

Figure 10. Output Pullup Resistance vs Temperature

Typical Characteristics (continued)

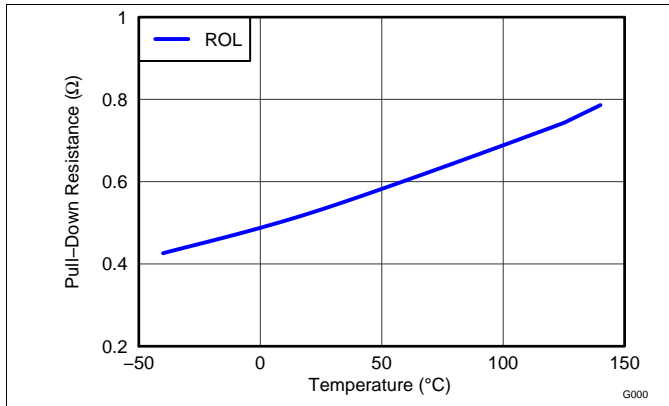

Figure 11. Output Pulldown Resistance vs Temperature

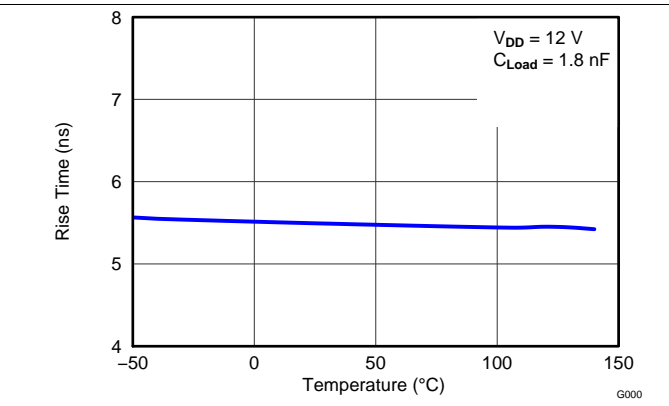

Figure 12. Rise Time vs Temperature

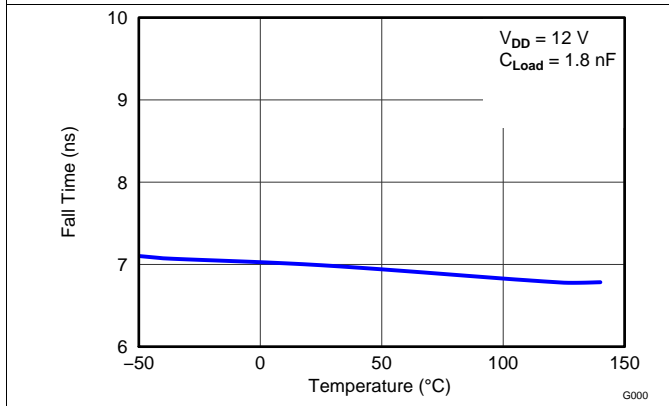

Figure 13. Fall Time vs Temperature

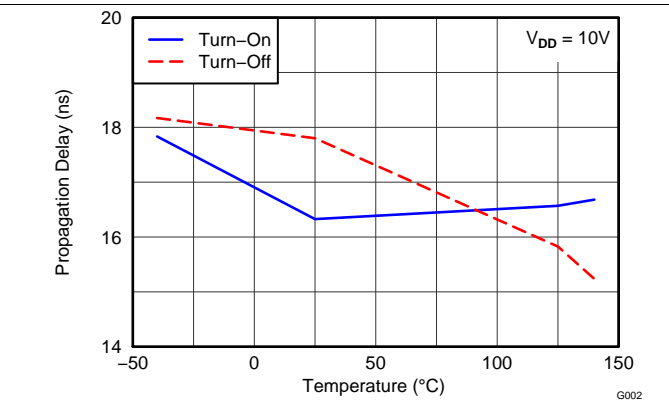

Figure 14. Input To Output Propagation Delay vs Temperature

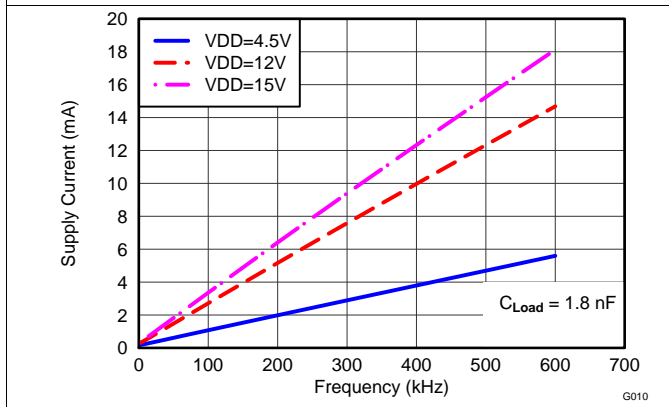

Figure 15. Operating Supply Current vs Frequency

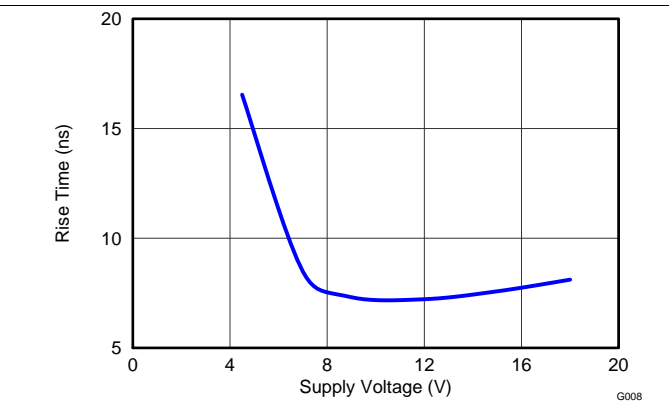

Figure 16. Rise Time vs Supply Voltage

Typical Characteristics (continued)

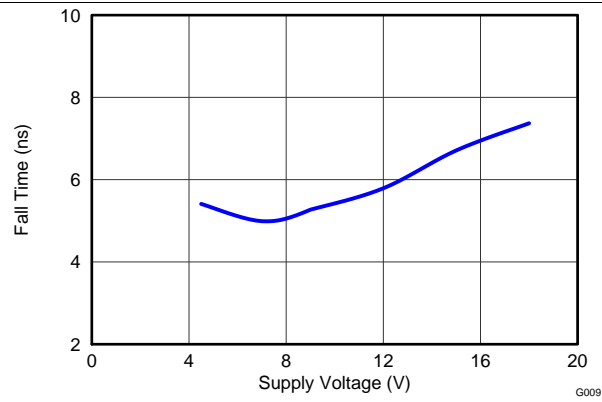

Figure 17. Fall Time vs Supply Voltage

9 Detailed Description

9.1 Overview

The UCC2751x single-channel, high-speed, low-side gate-driver device is capable of effectively driving MOSFET and IGBT power switches. Using a design that inherently minimizes shoot-through current, the UCC2751x device is capable of sourcing and sinking high peak-current pulses into capacitive loads offering rail-to-rail drive capability and extremely small propagation delay of 13 ns (typical).

The UCC2751x device provides 4-A source, 4-A sink (symmetrical drive) peak-drive current capability. The device is designed to operate over a wide V_{DD} range of 4.5 to 18 V, and a wide temperature range of -40°C to 140°C . Internal undervoltage lockout (UVLO) circuitry on the V_{DD} pin holds the output low outside V_{DD} operating range. The capability to operate at low voltage levels, such as below 5 V, along with best-in-class switching characteristics, is especially suited for driving emerging wide band-gap power-switching devices such as GaN power-semiconductor devices.

The UCC27518 device follows an inverting logic between the input and output, while the UCC27519 device follows noninverting logic. The input pins of the devices are based on what is known as CMOS input threshold logic. In CMOS input logic, the threshold voltage level is a function of the bias voltage on the V_{DD} pin of the device. This offers the benefits of higher noise immunity due to the higher threshold voltage (compared to logic level input thresholds), as well as the ability to accept slow dV/dt input signals for manipulating the propagation delay between the PWM controller signal and the gate driver output. For system robustness, internal pull-up and pull-down resistors on the input pins ensure that outputs are held low when the input pins are in floating condition.

Table 2. UCC2751x Family of Features and Benefits

| FEATURE | BENEFIT |
|--|--|
| High Source/Sink Current Capability 4 A/8 A (Asymmetrical) – UCC27511/2 4 A/4 A (Symmetrical) – UCC27516/7 | High current capability offers flexibility in employing UCC2751x family of devices to drive a variety of power switching devices at varying speeds |
| Best-in-class 13-ns (typ) Propagation delay | Extremely low pulse transmission distortion |
| Expanded V_{DD} Operating range of 4.5 V to 18 V | Flexibility in system design |
| Expanded Operating Temperature range of -40°C to 140°C (See Electrical Characteristics table) | Low V_{DD} operation ensures compatibility with emerging wide band-gap power devices such as GaN |
| V_{DD} UVLO Protection | Outputs are held low in UVLO condition, which ensures predictable, glitch-free operation at power-up and power-down |
| Outputs held low when input pins (INx) in floating condition | Safety feature, especially useful in passing abnormal condition tests during safety certification |
| Ability of input pins (and enable pin in UCC2751x) to handle voltage levels not restricted by V_{DD} pin bias voltage | System simplification, especially related to auxiliary bias supply architecture |
| Split output structure in UCC27511 (OUTH, OUTL) | Allows independent optimization of turnon and turnoff speeds |
| Strong sink current (8 A) and low pull-down impedance (0.375 Ω) in UCC27511/2 | High immunity to $C \times dV/dt$ Miller turnon events |
| CMOS/TTL compatible input threshold logic with wide hysteresis in UCC27511/2/6/7 | Enhanced noise immunity, while retaining compatibility with microcontroller logic level input signals (3.3 V, 5 V) optimized for digital power |
| CMOS input threshold logic in UCC2751x (V_{IN_H} – 70% V_{DD} , V_{IN_L} – 30% V_{DD}) | Well suited for slow input voltage signals, with flexibility to program delay circuits (RCD) |

9.2 Functional Block Diagrams

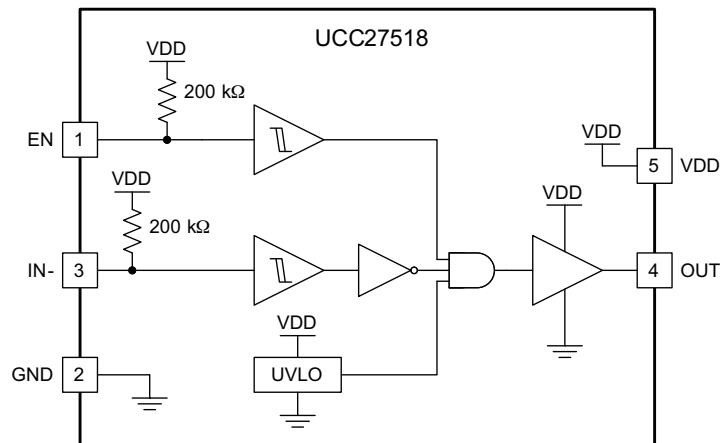

Figure 18. UCC27518 Functional Block Diagram

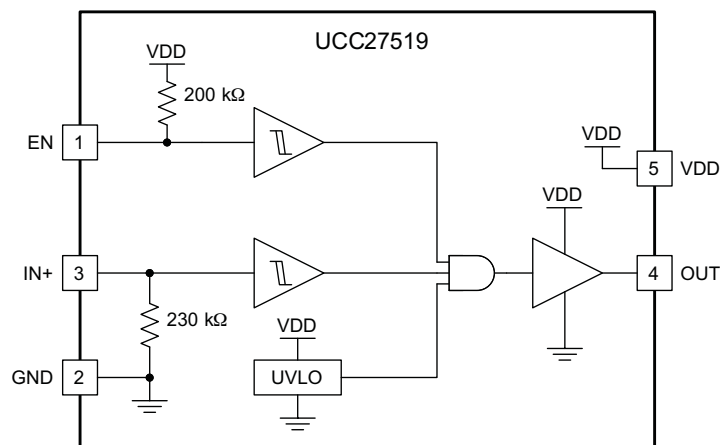

Figure 19. UCC27519 Functional Block Diagram

9.3 Feature Description

9.3.1 VDD and Undervoltage Lockout

The UCC2751x devices have internal Under Voltage LockOut (UVLO) protection feature on the VDD pin supply circuit blocks. Whenever the driver is in UVLO condition (i.e. when V_{DD} voltage less than V_{ON} during power up and when V_{DD} voltage is less than V_{OFF} during power down), this circuit holds all outputs LOW, regardless of the status of the inputs. The UVLO is typically 4.2 V with 300-mV typical hysteresis. This hysteresis helps prevent chatter when low V_{DD} supply voltages have noise from the power supply and also when there are droops in the VDD bias voltage when the system commences switching and there is a sudden increase in I_{DD} . The capability to operate at low voltage levels such as below 5 V, along with best-in-class switching characteristics, is especially suited for driving emerging GaN wide bandgap power semiconductor devices.

For example, at power up, the UCC2751x driver output remains LOW until the V_{DD} voltage reaches the UVLO threshold. The magnitude of the OUT signal rises with V_{DD} until steady-state V_{DD} is reached. In the noninverting device (PWM signal applied to IN+ pin) shown below, the output remains LOW until the UVLO threshold is reached, and then the output is in-phase with the input. In the inverting device (PWM signal applied to IN- pin) shown below the output remains LOW until the UVLO threshold is reached, and then the output is out-phase with the input.

Feature Description (continued)

Since the driver draws current from the VDD pin to bias all internal circuits, for the best high-speed circuit performance, two VDD bypass capacitors are recommended to prevent noise problems. The use of surface mount components is highly recommended. A 0.1- μF ceramic capacitor should be located as close as possible to the VDD to GND pins of the gate driver. In addition, a larger capacitor (such as 1 μF) with relatively low ESR should be connected in parallel and close proximity, in order to help deliver the high-current peaks required by the load. The parallel combination of capacitors should present a low impedance characteristic for the expected current levels and switching frequencies in the application.

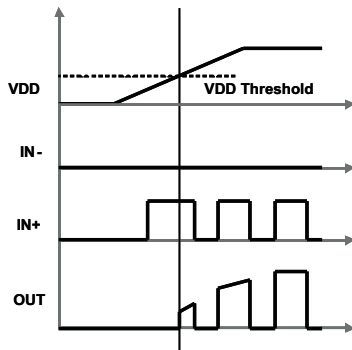

Figure 20. Power-Up (Noninverting Drive)

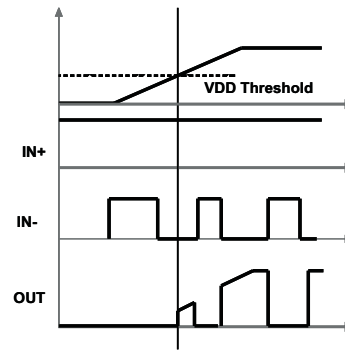

Figure 21. Power-Up (Inverting Drive)

9.3.2 Operating Supply Current

The UCC27518 and UCC27519 features very low quiescent I_{DD} currents. The typical operating supply current in Under Voltage LockOut (UVLO) state and fully-on state (under static and switching conditions) are summarized in [Figure 5](#), [Figure 6](#) and [Figure 7](#). The I_{DD} current when the device is fully on and outputs are in a static state (DC high or DC low, refer [Figure 7](#)) represents lowest quiescent I_{DD} current when all the internal logic circuits of the device are fully operational. The total supply current is the sum of the quiescent I_{DD} current, the average I_{OUT} current due to switching and finally any current related to pull-up resistors on the unused input pin. For example when the inverting input pin is pulled low additional current is drawn from VDD supply through the pull-up resistors (refer to [Pin Configuration and Functions](#) for the device Block Diagram). Knowing the operating frequency (f_{SW}) and the MOSFET gate (Q_G) charge at the drive voltage being used, the average I_{OUT} current can be calculated as product of Q_G and f_{SW} .

A complete characterization of the I_{DD} current as a function of switching frequency at different VDD bias voltages under 1.8-nF switching load is provided in [Figure 15](#). The strikingly linear variation and close correlation with theoretical value of average I_{OUT} indicates negligible shoot-through inside the gate-driver device attesting to its high-speed characteristics.

9.3.3 Input Stage

The input pins of UCC27518 and UCC27519 are based on CMOS input logic where the threshold voltage level is a function of the bias voltage applied on the VDD pin. Typically, the Input High Threshold (V_{INH}) is 55% VDD and Input Low Threshold (V_{INL}) is 39% VDD. Hysteresis (typically 19% VDD) available on the input threshold offers noise immunity. With high VDD voltages resulting in wide hysteresis, slow dV/dt input signals are acceptable in the IN_x pins and RC circuits can be inserted between the input PWM signal and the IN_x pins of UCC2751x, to program a delay between the input signal and output transition.

9.3.4 Enable Function

The Enable pin is based on a noninverting configuration (active high operation). When EN pin is driven high the output is enabled and when EN pin is driven low the output is disabled. Unlike input pin, the enable pin threshold is based on a TTL/CMOS compatible input threshold logic that does not vary with the supply voltage. Typically, the Enable High Threshold (V_{ENH}) is 2.1 V and Enable Low Threshold (V_{ENL}) is 1.25 V. Thus the EN pin can be effectively controlled using logic signals from 3.3-V and 5-V microcontrollers. The EN pin is internally pulled up to VDD using pull-up resistor as a result of which the output of the device is enabled in the default state. Hence the EN pin can be left floating or Not Connected (N/C) for standard operation, when enable feature is not needed. Essentially, this allows the UCC27518/19 devices to be pin-to-pin compatible with TI's previous generation drivers TPS2828/9 respectively, where pins #1 is N/C pin.

Feature Description (continued)

9.3.5 Output Stage

The UCC27518 and UCC27519 are capable of delivering 4-A source, 4-A sink (symmetrical drive) at $V_{DD} = 12$ V. The output stage of the UCC27518 and UCC27519 devices are illustrated in Figure 22. The UCC27518 and UCC27519 devices features a unique architecture on the output stage which delivers the highest peak source current when it is most needed during the Miller plateau region of the power switch turnon transition (when the power switch drain/collector voltage experiences dV/dt). The device output stage features a hybrid pull-up structure using a parallel arrangement of N-Channel and P-Channel MOSFET devices. By turning on the N-Channel MOSFET during a narrow instant when the output changes state from low to high, the gate-driver device is able to deliver a brief boost in the peak-sourcing current enabling fast turn on.

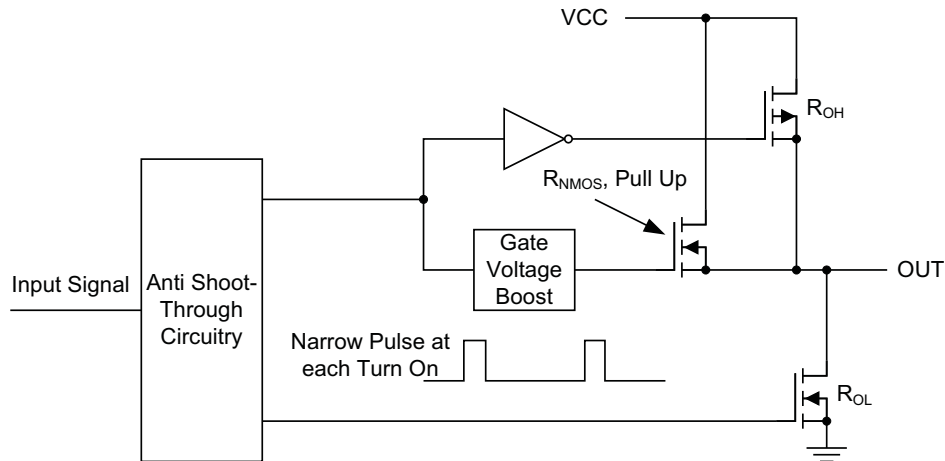

Figure 22. UCC2751x Gate Driver Output Structure

The R_{OH} parameter (see [Electrical Characteristics](#)) is a DC measurement and it is representative of the on-resistance of the P-Channel device only, since the N-Channel device is turned on only during output change of state from low to high. Thus the effective resistance of the hybrid pull-up stage is much lower than what is represented by R_{OH} parameter. The pull-down structure is composed of a N-Channel MOSFET only. The R_{OL} parameter (see [Electrical Characteristics](#)), which is also a DC measurement, is representative of true impedance of the pull-down stage in the device. In UCC27518 and UCC27519, the effective resistance of the hybrid pull-up structure is approximately $1.4 \times R_{OL}$.

The driver output voltage swings between VDD and GND providing rail-to-rail operation, thanks to the MOS output stage which delivers very low dropout. The presence of the MOSFET body diodes also offers low impedance to switching overshoots and undershoots. This means that in many cases, external Schottky diode clamps may be eliminated. The outputs of these drivers are designed to withstand 500-mA reverse current without either damage to the device or logic malfunction.

9.3.6 Low Propagation Delays

The UCC27518 and UCC27519 driver device features best-in-class input-to-output propagation delay of 17 ns (typ) at $V_{DD} = 12$ V. This promises the lowest level of pulse transmission distortion available from industry standard gate driver devices for high-frequency switching applications. As seen in Figure 14, there is very little variation of the propagation delay with temperature and supply voltage as well, offering typically less than 20-ns propagation delays across the entire range of application conditions.

9.4 Device Functional Modes

Table 3. Device Logic Table

| EN | UCC27518 | | UCC27519 | |
|------------------|------------------|---------|------------------|---------|
| | IN- PIN | OUT PIN | IN+ PIN | OUT PIN |
| H | L | H | L | L |
| H | H | L | H | H |
| L | Any | L | Any | L |
| Any | x ⁽¹⁾ | L | x ⁽¹⁾ | L |
| x ⁽¹⁾ | L | H | L | L |
| x ⁽¹⁾ | H | L | H | H |

(1) x = Floating Condition

10 Application and Implementation

NOTE

Information in the following applications sections is not part of the TI component specification, and TI does not warrant its accuracy or completeness. TI's customers are responsible for determining suitability of components for their purposes. Customers should validate and test their design implementation to confirm system functionality.

10.1 Application Information

High-current gate driver devices are required in switching power applications for a variety of reasons. In order to effect fast switching of power devices and reduce associated switching power losses, a powerful gate driver can be employed between the PWM output of controllers and the gates of the power semiconductor devices. Gate drivers also find other needs such as minimizing the effect of high-frequency switching noise by locating the high-current driver physically close to the power switch, driving gate-drive transformers and controlling floating power-device gates, reducing power dissipation and thermal stress in controllers by moving gate charge power losses into itself. Finally, emerging wide band-gap power device technologies such as GaN based switches, which are capable of supporting very high switching frequency operation, are driving very special requirements in terms of gate drive capability. These requirements include operation at low VDD voltages (5 V or lower), low propagation delays and availability in compact, low-inductance packages with good thermal capability. In summary gate-driver devices are extremely important components in switching power combining benefits of high-performance, low cost, component count and board space reduction and simplified system design.

10.2 Typical Application

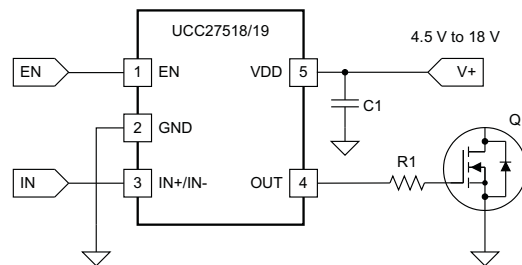

Figure 23. Typical Application Diagram

10.2.1 Design Requirements

When selecting the proper gate driver device for an end application, some design considerations must be evaluated first to make the most appropriate selection. Among these considerations are input-to-output configuration, the input threshold type, bias supply voltage levels, peak source and sink currents, availability of independent enable and disable functions, propagation delay, power dissipation, and package type.

Table 4. Design Parameters

| Design Parameter | Example Value |
|-------------------------------|---|
| Input-to-Output Logic | Noninverting |
| Input Threshold Type | CMOS type |
| VDD Bias Supply Voltage | 10 V (Minimum), 13 V (Nominal), 15 V (Peak) |
| Peak Source and Sink Currents | Minimum 3 A Source, Minimum 3 A Sink |
| Enable and Disable Function | Yes, Needed |
| Propagation Delay | Maximum 40 ns or less |

10.2.2 Detailed Design Procedure

10.2.2.1 Input-to-Output Logic

The design must specify which type of input-to-output configuration should be used. If turning on the power MOSFET or IGBT when the input signal is in high state is preferred, then the noninverting configuration must be selected. If turning off the power MOSFET or IGBT when the input signal is in high state is preferred, the inverting configuration must be chosen. The UCC27518 and UCC27519 devices follow inverting and noninverting logic, respectively.

10.2.2.2 Input Threshold Type

The type of input voltage threshold determines the type of controller used with the gate driver device. The UCC27518 and UCC27519 devices feature CMOS input threshold logic, with wide hysteresis. In CMOS input threshold logic, the threshold voltage level is a function of the bias voltage on the V_{DD} pin of the device. The typical high threshold is 55% of V_{DD} supply voltage, and the typical low threshold is 39% of V_{DD} supply voltage at $V_{DD}=12V$. There is built-in hysteresis, which is typically 16% of V_{DD} supply voltage. See [Electrical Characteristics](#) for the actual input threshold voltage levels and hysteresis specifications for the UCC27518 and UCC27519 devices at different V_{DD} bias levels.

In most applications, the absolute value of the threshold voltage offered by the CMOS logic will be higher (eg. $V_{INH} = 5.5 V$ if $V_{DD} = 10 V$) than what is offered by logic level threshold devices. This offers the following benefits:

- Better noise immunity due to the higher threshold level desirable in high power systems.
- Ability to accept slow dV/dt input signals, which allows designers to use RCD circuits on the input pin to program propagation delays in the application, as shown in [Figure 24](#).

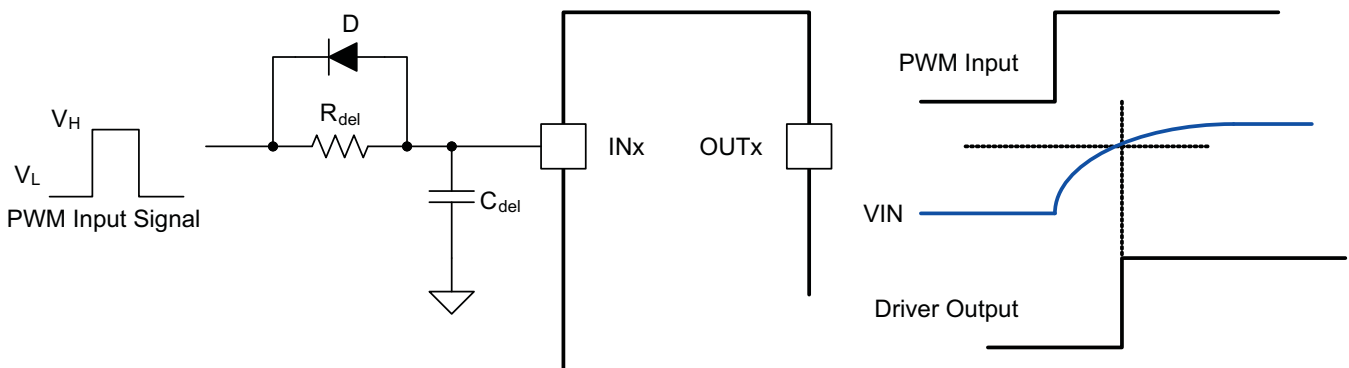

Figure 24. Using RCD Circuits

$$t_{del} = -R_{del}C_{del} \times \ln\left(\frac{V_L - V_{IN_H}}{V_H - V_L} + 1\right) \quad (1)$$

As a result of the CMOS input logic, the UCC27518 and UCC27519 devices cannot be driven directly by logic level control signals from microcontrollers, digital power controllers, or DSPs. The UCC27518 and UCC27519 are ideally suited for being driven by analog controllers driven by the same V_{DD} voltage as the gate driver devices.

10.2.2.3 V_{DD} Bias Supply Voltage

The bias supply voltage to be applied to the V_{DD} pin of the device should never exceed the values listed in [Recommended Operating Conditions](#). However, different power switches demand different voltage levels to be applied at the gate terminals for effective turn on and turnoff. With certain power switches, a positive gate voltage may be required for turn on, and a negative gate voltage may be required for turnoff, in which case the V_{DD} bias supply equals the voltage differential. With a wide operating range from 4.5 V to 18 V, the UCC27518 and UCC27519 devices can be used to drive a variety of power switches, such as Si MOSFETs (for example, $V_{GS} = 4.5 V, 10 V, 12 V$), IGBTs ($V_{GE} = 15 V, 18 V$), and wide-band gap power semiconductors (such as GaN, certain types of which allow no higher than 6 V to be applied to the gate terminals).

10.2.2.4 Peak Source and Sink Currents

Generally, the switching speed of the power switch during turn on and turnoff should be as fast as possible, to minimize switching losses. The gate driver device must be able to provide the required peak current for achieving the targeted switching speeds for the targeted power MOSFET. Using the example of a power MOSFET, the system requirement for the switching speed is typically described in terms of the slew rate of the drain-to-source voltage of the power MOSFET (such as dV_{DS}/dt).

For example, the system requirement might state that a SPP20N60C3 power MOSFET must be turned-on with a dV_{DS}/dt of 20V/ns or higher under a DC bus voltage of 400 V in a continuous-conduction-mode (CCM) boost PFC-converter application. This type of application is an inductive, hard-switching application, and reducing switching power losses is critical. This requirement means that the entire drain-to-source voltage swing during power MOSFET turnon event (from 400 V in the OFF state to $V_{DS(on)}$ in on state) must be completed in approximately 20 ns or less.

When the drain-to-source voltage swing occurs, the Miller charge of the power MOSFET (QGD parameter in SPP20N60C3 power MOSFET data sheet = 33 nC typical) is supplied by the peak current of gate driver. According to the power MOSFET inductive switching mechanism, the gate-to-source voltage of the power MOSFET at this time is the Miller plateau voltage, which is typically a few volts higher than the threshold voltage of the power MOSFET, $V_{GS(TH)}$. To achieve the targeted dV_{DS}/dt , the gate driver must be capable of providing the QGD charge in 20 ns or less. In other words, a peak current of 1.65 A (= 33 nC / 20 ns) or higher must be provided by the gate driver. The UCC27518 and UCC27519 gate driver is capable of providing 4-A peak sourcing current, which exceeds the design requirement and has the capability to meet the necessary switching speed.

The 2.4x overdrive capability provides an extra margin against part-to-part variations in the QGD parameter of the power MOSFET, along with additional flexibility to insert external gate resistors and fine tune the switching speed for efficiency versus EMI optimizations. However, in practical designs the parasitic trace inductance in the gate drive circuit of the PCB will have a definitive role to play on the power MOSFET switching speed. The effect of this trace inductance is to limit the dI/dt of the output current pulse of the gate driver.

To illustrate this, consider the output current pulse waveform from the gate driver to be approximated to a triangular profile, where the area under the triangle ($\frac{1}{2} \times I_{PEAK} \times \text{time}$) would equal the total gate charge of the power MOSFET (QG parameter in SPP20N60C3 power MOSFET datasheet = 87 nC typical). If the parasitic trace inductance limits the dI/dt , the full peak current capability of the gate driver may not be fully achieved in the time required to deliver the QG required for the power MOSFET switching. In other words, the time parameter in the equation would dominate and the I_{PEAK} value of the current pulse would be much less than the true peak current capability of the device, while the required QG is still delivered. Because of this, the desired switching speed may not be realized, even when theoretical calculations indicate the gate driver is capable of achieving the targeted switching speed. Thus, place the gate driver device very close to the power MOSFET and design a tight gate drive-loop with minimal PCB trace inductance to realize the full peak-current capability of the gate driver.

10.2.2.5 Enable and Disable Function

Certain applications demand independent control of the output state of the driver without involving the input signal. The UCC27518 and UCC27519 devices offer the Enable pin, which achieves this.

10.2.2.6 Propagation Delay

The acceptable propagation delay from the gate driver is dependent on the switching frequency at which it is used, and the acceptable level of pulse distortion to the system. The UCC27518 and UCC27519 devices feature industry best-in-class 17-ns (typical) propagation delays, which ensure very little pulse distortion and allow operation at very high-frequencies. See [Switching Characteristics](#) for the propagation and switching characteristics of the UCC27518 and UCC27519 devices.

10.2.3 Application Curve

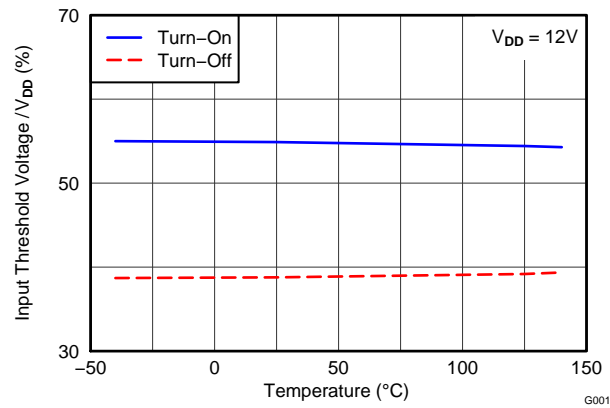

Figure 25. Input Threshold vs Temperature

11 Power Supply Recommendations

The bias supply voltage range for which the UCC27518 and UCC27519 device is rated to operate is from 4.5 V to 18 V. The lower end of this range is governed by the internal under voltage-lockout (UVLO) protection feature on the V_{DD} pin supply circuit blocks. Whenever the driver is in UVLO condition with the V_{DD} pin voltage below the $V_{(ON)}$ supply start threshold, this feature holds the output low, regardless of the status of the inputs. The upper end of this range is driven by the 20-V absolute maximum voltage rating of the V_{DD} pin of the device (which is a stress rating). Keeping a 2-V margin to allow for transient voltage spikes, the maximum recommended voltage for the V_{DD} pin is 18 V.

The UVLO protection feature also involves a hysteresis function. When the V_{DD} pin bias voltage has exceeded the threshold voltage and the device begins to operate, if the voltage drops, the device continues to deliver normal functionality unless the voltage drop exceeds the hysteresis specification $V_{DD(hys)}$. While operating at or near the 4.5 V range, ensure that the voltage ripple on the auxiliary power supply output is smaller than the hysteresis specification of the device to avoid triggering device shutdown.

During system shutdown, the device operation continues until the V_{DD} pin voltage has dropped below the $V_{(OFF)}$ threshold, which must be accounted for while evaluating system shutdown timing design requirements. Likewise, at system startup the device does not begin operation until the V_{DD} pin voltage has exceeded above the $V_{(ON)}$ threshold. The quiescent current consumed by the internal circuit blocks of the device is supplied through the V_{DD} pin. The charge for source current pulses delivered by the OUT pin is also supplied through the same V_{DD} pin. As a result, every time a current is sourced out of the output pin (OUT), a corresponding current pulse is delivered into the device through the V_{DD} pin. Therefore, ensure that local bypass capacitors are provided between the V_{DD} and GND pins and located as close to the device as possible, for the purpose of decoupling. A low ESR, ceramic surface mount capacitor is necessary. TI recommends to have 2 capacitors; a 100-nF ceramic surface-mount capacitor which can be nudged very close to the pins of the device, and another surface-mount capacitor of few microfarads added in parallel.

12 Layout

12.1 Layout Guidelines

Proper PCB layout is extremely important in a high-current, fast-switching circuit to provide appropriate device operation and design robustness. The UCC27518 and UCC27519 gate driver incorporates short-propagation delays and powerful output stages capable of delivering large current peaks with very fast rise and fall times at the gate of power switch to facilitate voltage transitions very quickly. At higher VDD voltages, the peak-current capability is even higher (4-A/4-A peak current is at VDD = 12 V). Very high di/dt can cause unacceptable ringing if the trace lengths and impedances are not well controlled. The following circuit layout guidelines are strongly recommended when designing with these high-speed drivers.

- Locate the driver device as close as possible to power device in order to minimize the length of high-current traces between the output pins and the gate of the power device.
- Locate the VDD bypass capacitors between VDD and GND as close as possible to the driver with minimal trace length to improve the noise filtering. These capacitors support high-peak current being drawn from VDD during turnon of power MOSFET. TI highly recommends using low-inductance SMD components such as chip resistors and chip capacitors.
- The turnon and turnoff current loop paths (driver device, power MOSFET and VDD bypass capacitor) should be minimized as much as possible in order to keep the stray inductance to a minimum. High di/dt is established in these loops at two instances – during turnon and turnoff transients, which will induce significant voltage transients on the output pin of the driver device and gate of the power switch.
- Wherever possible parallel the source and return traces, taking advantage of flux cancellation.
- Separate power traces and signal traces, such as output and input signals.
- Star-point grounding is a good way to minimize noise coupling from one current loop to another. The GND of the driver should be connected to the other circuit nodes such as source of power switch, ground of PWM controller etc at one, single point. The connected paths should be as short as possible to reduce inductance and be as wide as possible to reduce resistance.
- Use a ground plane to provide noise shielding. Fast rise and fall times at OUT may corrupt the input signals during transition. The ground plane must not be a conduction path for any current loop. Instead the ground plane must be connected to the star-point with one single trace to establish the ground potential. In addition

Layout Guidelines (continued)

to noise shielding, the ground plane can help in power dissipation as well.

12.2 Layout Example

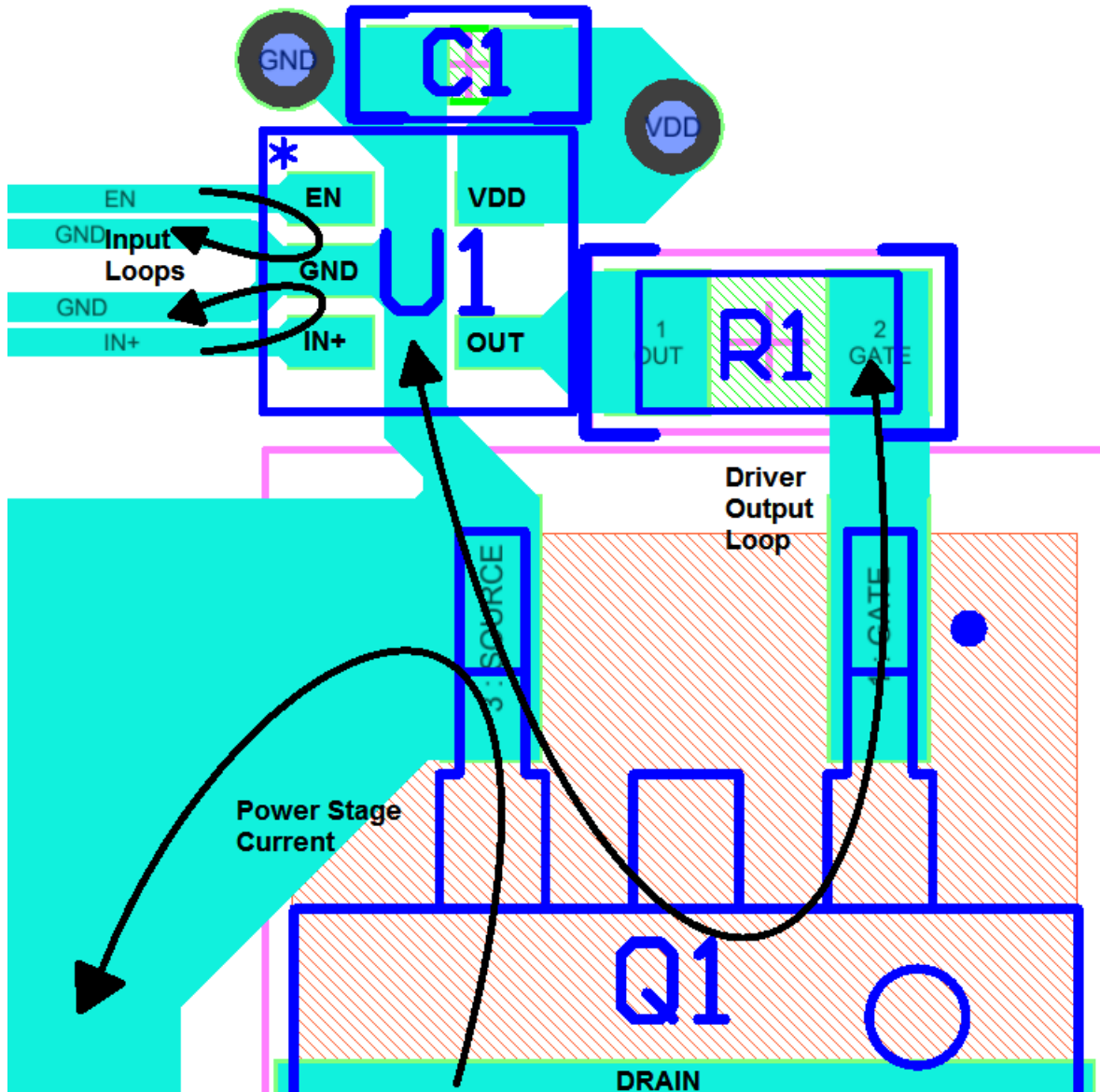

Figure 26. Layout Example

12.3 Thermal Considerations

The useful range of a driver is greatly affected by the drive power requirements of the load and the thermal characteristics of the package. For a gate driver to be useful over a particular temperature range, the package must allow for the efficient removal of the heat produced while keeping the junction temperature within rated limits. The thermal metrics for the driver package is summarized in [Thermal Information](#). For detailed information regarding the thermal information table, refer to the Application Note from Texas Instruments entitled *IC Package Thermal Metrics* (SPRA953).

12.4 Power Dissipation

Power dissipation of the gate driver has two portions as shown in equation below:

$$P_{DISS} = P_{DC} + P_{SW} \quad (2)$$

The DC portion of the power dissipation is $P_{DC} = I_Q \times V_{DD}$ where I_Q is the quiescent current for the driver. The quiescent current is the current consumed by the device to bias all internal circuits such as input stage, reference voltage, logic circuits, protections etc and also any current associated with switching of internal devices when the driver output changes state (such as charging and discharging of parasitic capacitances, parasitic shoot-through etc). The UCC27518 and UCC27519 features very low quiescent currents (less than 1 mA, refer [Figure 7](#)) and contains internal logic to eliminate any shoot-through in the output driver stage. Thus the effect of the P_{DC} on the total power dissipation within the gate driver can be safely assumed to be negligible.

The power dissipated in the gate-driver package during switching (P_{SW}) depends on the following factors:

- Gate charge required of the power device (usually a function of the drive voltage V_G , which is very close to input bias supply voltage V_{DD} due to low V_{OH} drop-out).
- Switching frequency.
- Use of external gate resistors.

When a driver device is tested with a discrete, capacitive load it is a fairly simple matter to calculate the power that is required from the bias supply. The energy that must be transferred from the bias supply to charge the capacitor is given by:

$$E_G = \frac{1}{2} C_{LOAD} V_{DD}^2$$

where

- C_{LOAD} is load capacitor
 - V_{DD} is bias voltage feeding the driver
- (3)

There is an equal amount of energy dissipated when the capacitor is charged. This leads to a total power loss given by the following:

$$P_G = C_{LOAD} V_{DD}^2 f_{SW}$$

where

- f_{SW} is the switching frequency
- (4)

The switching load presented by a power MOSFET/IGBT can be converted to an equivalent capacitance by examining the gate charge required to switch the device. This gate charge includes the effects of the input capacitance plus the added charge needed to swing the drain voltage of the power device as it switches between the ON and OFF states. Most manufacturers provide specifications of typical and maximum gate charge, in nC, to switch the device under specified conditions. Using the gate charge Q_g , one can determine the power that must be dissipated when charging a capacitor. This is done by using the equation, $Q_G = C_{LOAD} \times V_{DD}$, to provide the following equation for power:

$$P_G = C_{LOAD} V_{DD}^2 f_{SW} = Q_g V_{DD} f_{SW} \quad (5)$$

This power P_G is dissipated in the resistive elements of the circuit when the MOSFET/IGBT is being turned on or off. Half of the total power is dissipated when the load capacitor is charged during turnon, and the other half is dissipated when the load capacitor is discharged during turnoff. When no external gate resistor is employed between the driver and MOSFET/IGBT, this power is completely dissipated inside the driver package. With the use of external gate-drive resistors, the power dissipation is shared between the internal resistance of driver and external gate resistor in accordance to the ratio of the resistances (more power dissipated in the higher resistance component). Based on this simplified analysis, the driver power dissipation during switching is calculated as follows:

$$P_{SW} = Q_G \times V_{DD} \times f_{SW} \times \left(\frac{R_{OFF}}{R_{OFF} + R_{GATE}} + \frac{R_{ON}}{R_{ON} + R_{GATE}} \right)$$

where

- $R_{OFF} = R_{OL}$
 - R_{ON} (effective resistance of pull-up structure) = $1.4 \times R_{OL}$
- (6)

13 Device and Documentation Support

13.1 Related Links

The table below lists quick access links. Categories include technical documents, support and community resources, tools and software, and quick access to sample or buy.

Table 5. Related Links

| PARTS | PRODUCT FOLDER | SAMPLE & BUY | TECHNICAL DOCUMENTS | TOOLS & SOFTWARE | SUPPORT & COMMUNITY |
|----------|----------------------------|----------------------------|----------------------------|----------------------------|----------------------------|
| UCC27518 | Click here | Click here | Click here | Click here | Click here |
| UCC27519 | Click here | Click here | Click here | Click here | Click here |

13.2 Trademarks

All trademarks are the property of their respective owners.

13.3 Electrostatic Discharge Caution



These devices have limited built-in ESD protection. The leads should be shorted together or the device placed in conductive foam during storage or handling to prevent electrostatic damage to the MOS gates.

13.4 Glossary

[SLYZ022](#) — *TI Glossary*.

This glossary lists and explains terms, acronyms, and definitions.

14 Mechanical, Packaging, and Orderable Information

The following pages include mechanical, packaging, and orderable information. This information is the most current data available for the designated devices. This data is subject to change without notice and revision of this document. For browser-based versions of this data sheet, refer to the left-hand navigation.

PACKAGING INFORMATION

| Orderable Device | Status (1) | Package Type | Package Drawing | Pins | Package Qty | Eco Plan (2) | Lead finish/ Ball material (6) | MSL Peak Temp (3) | Op Temp (°C) | Device Marking (4/5) | Samples |
|------------------|---------------|--------------|-----------------|------|-------------|-----------------|--------------------------------------|----------------------|--------------|-------------------------|-------------------------|
| UCC27518DBVR | ACTIVE | SOT-23 | DBV | 5 | 3000 | RoHS & Green | NIPDAU | Level-1-260C-UNLIM | -40 to 140 | 7518 | Samples |
| UCC27518DBVT | ACTIVE | SOT-23 | DBV | 5 | 250 | RoHS & Green | NIPDAU | Level-1-260C-UNLIM | -40 to 140 | 7518 | Samples |
| UCC27519DBVR | ACTIVE | SOT-23 | DBV | 5 | 3000 | RoHS & Green | NIPDAU | Level-1-260C-UNLIM | -40 to 140 | 7519 | Samples |
| UCC27519DBVT | ACTIVE | SOT-23 | DBV | 5 | 250 | RoHS & Green | NIPDAU | Level-1-260C-UNLIM | -40 to 140 | 7519 | Samples |

(1) The marketing status values are defined as follows:

ACTIVE: Product device recommended for new designs.

LIFEBUY: TI has announced that the device will be discontinued, and a lifetime-buy period is in effect.

NRND: Not recommended for new designs. Device is in production to support existing customers, but TI does not recommend using this part in a new design.

PREVIEW: Device has been announced but is not in production. Samples may or may not be available.

OBSOLETE: TI has discontinued the production of the device.

(2) **RoHS:** TI defines "RoHS" to mean semiconductor products that are compliant with the current EU RoHS requirements for all 10 RoHS substances, including the requirement that RoHS substance do not exceed 0.1% by weight in homogeneous materials. Where designed to be soldered at high temperatures, "RoHS" products are suitable for use in specified lead-free processes. TI may reference these types of products as "Pb-Free".

RoHS Exempt: TI defines "RoHS Exempt" to mean products that contain lead but are compliant with EU RoHS pursuant to a specific EU RoHS exemption.

Green: TI defines "Green" to mean the content of Chlorine (Cl) and Bromine (Br) based flame retardants meet JS709B low halogen requirements of <=1000ppm threshold. Antimony trioxide based flame retardants must also meet the <=1000ppm threshold requirement.

(3) MSL, Peak Temp. - The Moisture Sensitivity Level rating according to the JEDEC industry standard classifications, and peak solder temperature.

(4) There may be additional marking, which relates to the logo, the lot trace code information, or the environmental category on the device.

(5) Multiple Device Markings will be inside parentheses. Only one Device Marking contained in parentheses and separated by a "-" will appear on a device. If a line is indented then it is a continuation of the previous line and the two combined represent the entire Device Marking for that device.

(6) Lead finish/Ball material - Orderable Devices may have multiple material finish options. Finish options are separated by a vertical ruled line. Lead finish/Ball material values may wrap to two lines if the finish value exceeds the maximum column width.

Important Information and Disclaimer: The information provided on this page represents TI's knowledge and belief as of the date that it is provided. TI bases its knowledge and belief on information provided by third parties, and makes no representation or warranty as to the accuracy of such information. Efforts are underway to better integrate information from third parties. TI has taken and

continues to take reasonable steps to provide representative and accurate information but may not have conducted destructive testing or chemical analysis on incoming materials and chemicals. TI and TI suppliers consider certain information to be proprietary, and thus CAS numbers and other limited information may not be available for release.

In no event shall TI's liability arising out of such information exceed the total purchase price of the TI part(s) at issue in this document sold by TI to Customer on an annual basis.

TAPE AND REEL INFORMATION



QUADRANT ASSIGNMENTS FOR PIN 1 ORIENTATION IN TAPE



*All dimensions are nominal

| Device | Package Type | Package Drawing | Pins | SPQ | Reel Diameter (mm) | Reel Width W1 (mm) | A0 (mm) | B0 (mm) | K0 (mm) | P1 (mm) | W (mm) | Pin1 Quadrant |
|--------------|--------------|-----------------|------|------|--------------------|--------------------|---------|---------|---------|---------|--------|---------------|
| UCC27518DBVR | SOT-23 | DBV | 5 | 3000 | 180.0 | 8.4 | 3.2 | 3.2 | 1.4 | 4.0 | 8.0 | Q3 |
| UCC27518DBVT | SOT-23 | DBV | 5 | 250 | 179.0 | 8.4 | 3.2 | 3.2 | 1.4 | 4.0 | 8.0 | Q3 |
| UCC27519DBVR | SOT-23 | DBV | 5 | 3000 | 179.0 | 8.4 | 3.2 | 3.2 | 1.4 | 4.0 | 8.0 | Q3 |
| UCC27519DBVT | SOT-23 | DBV | 5 | 250 | 179.0 | 8.4 | 3.2 | 3.2 | 1.4 | 4.0 | 8.0 | Q3 |

TAPE AND REEL BOX DIMENSIONS

*All dimensions are nominal

| Device | Package Type | Package Drawing | Pins | SPQ | Length (mm) | Width (mm) | Height (mm) |
|--------------|--------------|-----------------|------|------|-------------|------------|-------------|
| UCC27518DBVR | SOT-23 | DBV | 5 | 3000 | 200.0 | 183.0 | 25.0 |
| UCC27518DBVT | SOT-23 | DBV | 5 | 250 | 203.0 | 203.0 | 35.0 |
| UCC27519DBVR | SOT-23 | DBV | 5 | 3000 | 200.0 | 183.0 | 25.0 |
| UCC27519DBVT | SOT-23 | DBV | 5 | 250 | 203.0 | 203.0 | 35.0 |

EXAMPLE BOARD LAYOUT

DBV0005A

SOT-23 - 1.45 mm max height

SMALL OUTLINE TRANSISTOR



LAND PATTERN EXAMPLE
EXPOSED METAL SHOWN
SCALE:15X

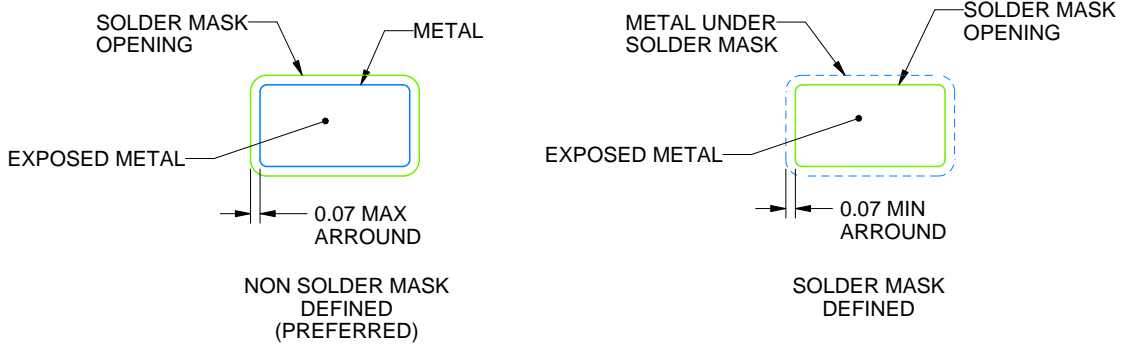

SOLDER MASK DETAILS

4214839/E 09/2019

NOTES: (continued)

- 5. Publication IPC-7351 may have alternate designs.
- 6. Solder mask tolerances between and around signal pads can vary based on board fabrication site.

EXAMPLE STENCIL DESIGN

DBV0005A

SOT-23 - 1.45 mm max height

SMALL OUTLINE TRANSISTOR



SOLDER PASTE EXAMPLE
BASED ON 0.125 mm THICK STENCIL
SCALE:15X

4214839/E 09/2019

NOTES: (continued)

7. Laser cutting apertures with trapezoidal walls and rounded corners may offer better paste release. IPC-7525 may have alternate design recommendations.
8. Board assembly site may have different recommendations for stencil design.

IMPORTANT NOTICE AND DISCLAIMER

TI PROVIDES TECHNICAL AND RELIABILITY DATA (INCLUDING DATASHEETS), DESIGN RESOURCES (INCLUDING REFERENCE DESIGNS), APPLICATION OR OTHER DESIGN ADVICE, WEB TOOLS, SAFETY INFORMATION, AND OTHER RESOURCES "AS IS" AND WITH ALL FAULTS, AND DISCLAIMS ALL WARRANTIES, EXPRESS AND IMPLIED, INCLUDING WITHOUT LIMITATION ANY IMPLIED WARRANTIES OF MERCHANTABILITY, FITNESS FOR A PARTICULAR PURPOSE OR NON-INFRINGEMENT OF THIRD PARTY INTELLECTUAL PROPERTY RIGHTS.

These resources are intended for skilled developers designing with TI products. You are solely responsible for (1) selecting the appropriate TI products for your application, (2) designing, validating and testing your application, and (3) ensuring your application meets applicable standards, and any other safety, security, or other requirements. These resources are subject to change without notice. TI grants you permission to use these resources only for development of an application that uses the TI products described in the resource. Other reproduction and display of these resources is prohibited. No license is granted to any other TI intellectual property right or to any third party intellectual property right. TI disclaims responsibility for, and you will fully indemnify TI and its representatives against, any claims, damages, costs, losses, and liabilities arising out of your use of these resources.

TI's products are provided subject to TI's Terms of Sale (<https://www.ti.com/legal/termsofsale.html>) or other applicable terms available either on [ti.com](https://www.ti.com) or provided in conjunction with such TI products. TI's provision of these resources does not expand or otherwise alter TI's applicable warranties or warranty disclaimers for TI products.

Mailing Address: Texas Instruments, Post Office Box 655303, Dallas, Texas 75265
Copyright © 2021, Texas Instruments Incorporated