

### Product Overview

The QPB7425 is a GaAs pHEMT single ended RF amplifier IC featuring 25 dB of flat gain and low noise. This IC is designed to support Fiber to The Home (FTTH) applications from 47 to 1218 MHz using a single 8 V supply. Operation down to 3 V is possible for applications with reduced linearity requirements. QPB7425 offers extremely low noise and distortion plus high gain in a SOT-89 package for convenient layout and design in set top and infrastructure projects for 75 Ω CATV and satellite applications.



SOT-89 Package

### Functional Block Diagram

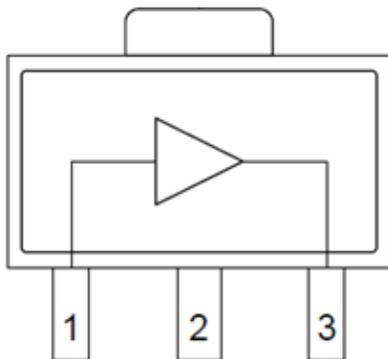

Top View

### Key Features

- 47 MHz to 1218 MHz Operation
- 3 V, 5 V, or 8 V supply
- Gain; 25 dB Typical
- Noise Figure; 0.9 dB Typical at 850 MHz
- Adjustable Bias Using External Resistors
- Convenient SOT-89 Package
- RoHS Compliant

### Applications

- FTTH GPON and GEAPON
- DOCSIS 3.1
- Head End CMTS Equipment
- Optical Nodes
- Return Path
- Satellite Low Noise Amplifier
- Cable Modem and Set Top Box
- 50ohm LNA to 1.6GHz

### Ordering Information

Part Number	Description
QPB7425SB	Sample bag with 5 pieces
QPB7425SR	7" Reel with 100 pieces
QPB7425TR13	13" Reel with 2500 pieces
QPB7425PCK	47 – 1218 MHz PCBA with 5 pc sample bag

## Absolute Maximum Ratings

Parameter	Rating
Supply Voltage ( $V_{DD}$ )	+10 V
Supply Current ( $I_{DD}$ )	140 mA
Maximum Input Level	65 dBmV
Operating Temperature Range	-40 to +85 °C
Storage Temperature Range	-65 to +150 °C
Maximum Junction Temperature	+150 °C

Exceeding any one or a combination of the Absolute Maximum Rating conditions may cause permanent damage to the device. Extended application of Absolute Maximum Rating conditions to the device may reduce device reliability.

## Electrical Specifications – 3V

Parameter	Condition <sup>(1)</sup>	Min	Typ	Max	Unit
Supply Voltage ( $V_{DD}$ )			3		V
Supply Current ( $I_{DD}$ )			40		mA
Frequency Range		47		1218	MHz
Gain			24		dB
Gain Slope			0.5		dB
Reverse Isolation			26		dB
Input Return Loss			18		dB
Output Return Loss			18		dB
Noise Figure			1.2		dB
CSO	21 dBmV / ch output, 80 NTSC + 108 QAM, flat		51		dBc
CTB	21 dBmV / ch output, 80 NTSC + 108 QAM, flat		73		dBc
CCN	21 dBmV / ch output, 80 NTSC + 108 QAM, flat		50		dB
OIP2L	7 dBm / tone output		36		dBm
OIP2H	7 dBm / tone output		37		dBm
OIP3	7 dBm / tone output		27		dBm
OP1dB			15.4		dBm
Thermal Resistance	$\Theta_{JC}$		35		°C/W

Notes:

1. Typical performance at these conditions: Temp = +25 °C,  $V_{DD}$  = +8 V, 75 Ω system, Full band unless otherwise noted

## Electrical Specifications – 5V

Parameter	Condition <sup>(1)</sup>	Min	Typ	Max	Unit
Supply Voltage ( $V_{DD}$ )			5		V
Supply Current ( $I_{DD}$ )			55		mA
Frequency Range		47		1218	MHz
Gain			25		dB
Gain Slope			0.5		dB
Reverse Isolation			26.4		dB
Input Return Loss			20		dB
Output Return Loss			17		dB
Noise Figure			1.1		dB
CSO	21 dBmV / ch output, 80 NTSC + 108 QAM, flat		59		dBc
CTB	21 dBmV / ch output, 80 NTSC + 108 QAM, flat		75		dBc
CCN	21 dBmV / ch output, 80 NTSC + 108 QAM, flat		52		dB
OIP2L	7 dBm / tone output		44		dBm
OIP2H	7 dBm / tone output		41		dBm
OIP3	7 dBm / tone output		37		dBm
OP1dB			20.6		dBm
Thermal Resistance	$\Theta_{JC}$		35		$^{\circ}\text{C}/\text{W}$

Notes:

1. Typical performance at these conditions: Temp = +25  $^{\circ}\text{C}$ ,  $V_{DD}$  = +5V, 75  $\Omega$  system, Full band unless otherwise noted

### Electrical Specifications – 8V

Parameter	Condition <sup>(1)</sup>	Min	Typ	Max	Unit
Supply Voltage ( $V_{DD}$ )			8		V
Supply Current ( $I_{DD}$ )			105		mA
Frequency Range		47		1218	MHz
Gain			25		dB
Gain Slope			-0.5		dB
Reverse Isolation			27		dB
Input Return Loss			19		dB
Output Return Loss			16		dB
Noise Figure			1.1		dB
CSO	29 dBmV / ch output, 80 NTSC + 108 QAM, flat		57		dBc
CTB	29 dBmV / ch output, 80 NTSC + 108 QAM, flat		80		dBc
CCN	29 dBmV / ch output, 80 NTSC + 108 QAM, flat		56		dB
OIP2L	7 dBm / tone output		50		dBm
OIP2H	7 dBm / tone output		45		dBm
OIP3	7 dBm / tone output		39		dBm
OP1dB			24.7		dBm
Thermal Resistance	$\Theta_{JC}$		35		$^{\circ}\text{C}/\text{W}$

Notes:

1. Typical performance at these conditions: Temp = +25  $^{\circ}\text{C}$ ,  $V_{DD}$  = +8 V, 75  $\Omega$  system, Full band unless otherwise noted





# QPB7425

## 75 $\Omega$ 25 dB CATV Amplifier (47 – 1218 MHz)

### Evaluation Board Bill of Materials

Designator	Description	Manufacturer	Part Number
PCB	QPB7420-4000	DDI	QPB7420-4000(A)
U1	25dB FTTH Amplifier	Qorvo	QPB7425SB
B1, B2	FER, BEAD, 1.8K, 200mA, 0402	TDK	MMZ1005A182ET000
C1, C2, C5	CAP, 10000pF, 10%, 50V, X7R, 0402	Murata Electronics	GRM155R71H103KA88D
C3	CAP, 1.2pF, $\pm$ 0.05pF, 50V, HI-Q, 0402	Murata Electronics	GJM1555C1H1R2WB01D
C4	CAP, 0.3pF, $\pm$ 0.05pF, 50V, HI-Q, 0402	Murata Electronics	GJM1555C1HR30WB01D
C6	CAP, 330pF, 10%, 50V, X8L, 0402	Murata Electronics	GCM155L81H331KA37D
R1	RES, 1.5 K $\Omega$ , 1%, 1/16W, 0402	KOA Speer	RK73H1ETTP1501F
R2	RES, 360 $\Omega$ , 1%, 1/10W, 0402	Kamaya, Inc	RMC1/16SK3600FTH
R3	RES, 1M, 5%, 1/16W, 0402	Kamaya, Inc	RMC1/16S-105JTH
R5	RES, 0 $\Omega$ , 5%, 1/10W, 0402	Kamaya, Inc	RMC1/16SJPTH
L1	IND, 8.2nH, 2%, 550mA, M/L, 0402	Murata Electronics	LQG15HS8N2G02D
L2	IND, 5.6nH, $\pm$ 0.1nH, 650mA, M/L, 0402	Murata Electronics	LQG15HS5N6B02D
L3	IND, 68nH, 2%, 250mA, M/L, 0402	Murata Electronics	LQG15HS68NG02D
J1, J2	CONN, F FEM EDGE MOUNT, 75 $\Omega$ , 0.068"	Millimeter Wave	MW-846-C-DD-75
J3, J4	TERM. SOLDER TURRET. .062 PCB	Mill-Max Mfg	2533-0-00-44-00-00-07-0
R4, C7	Not Populated	N/A	N/A

### Evaluation Board Assembly Drawing





Performance Data – 8V

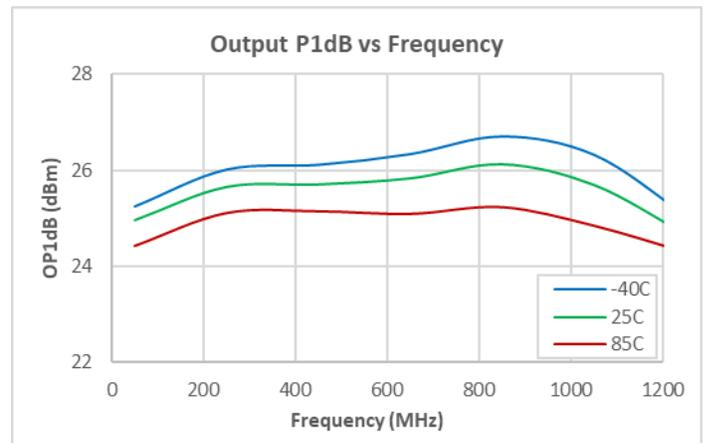
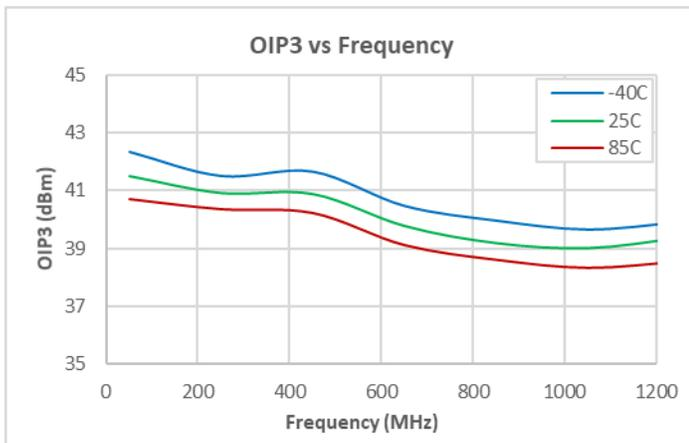
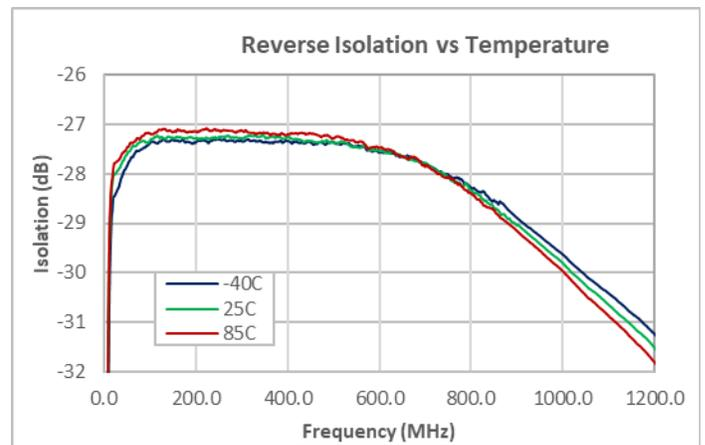
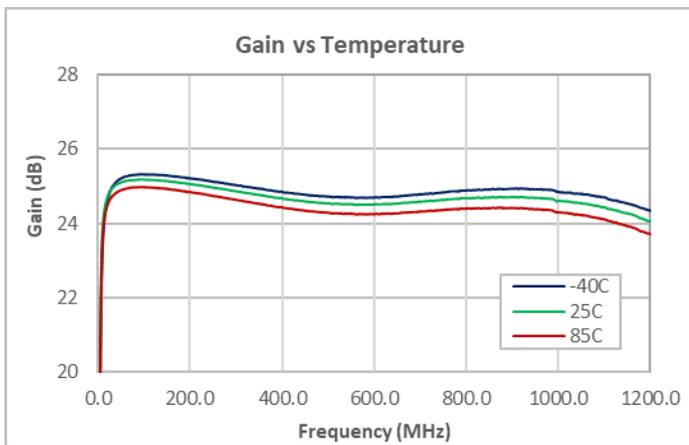
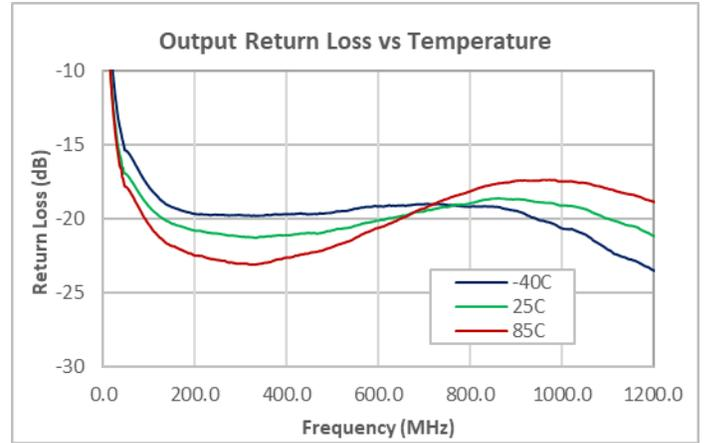
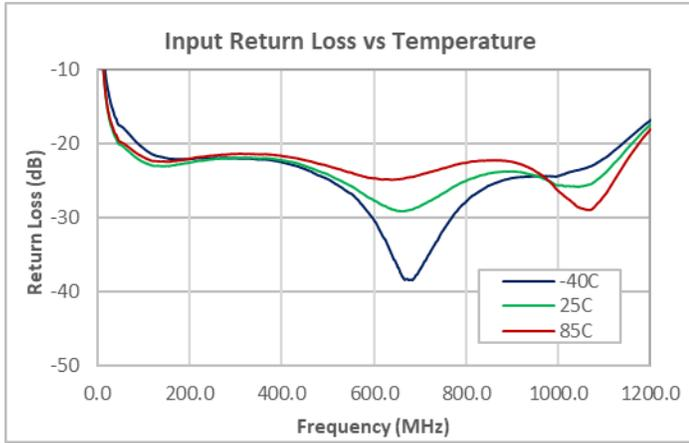

Notes:  
 (1) OIP3: 7 dBm/ tone output

### Performance Data – 8V

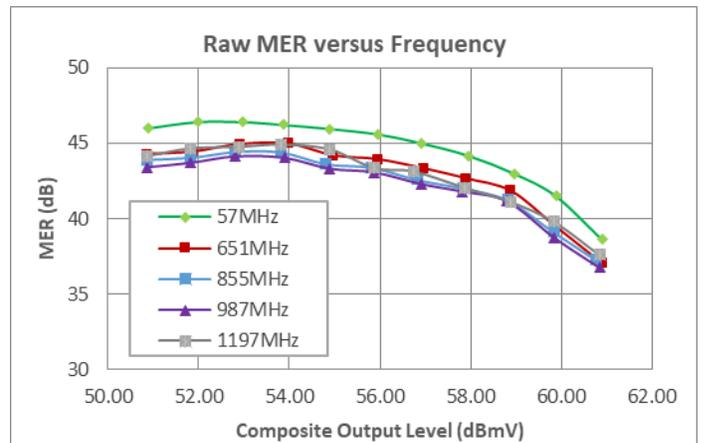
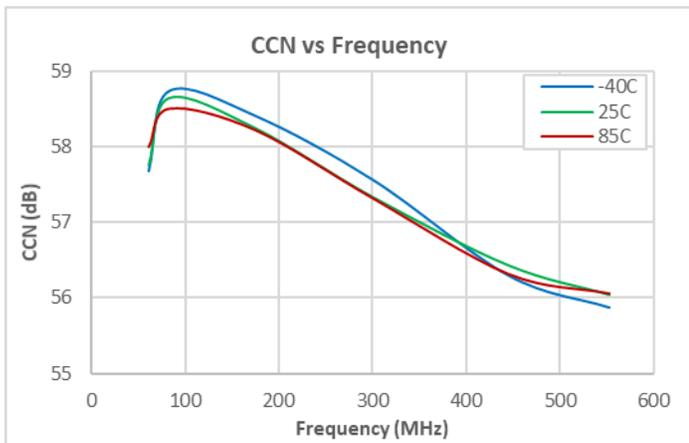
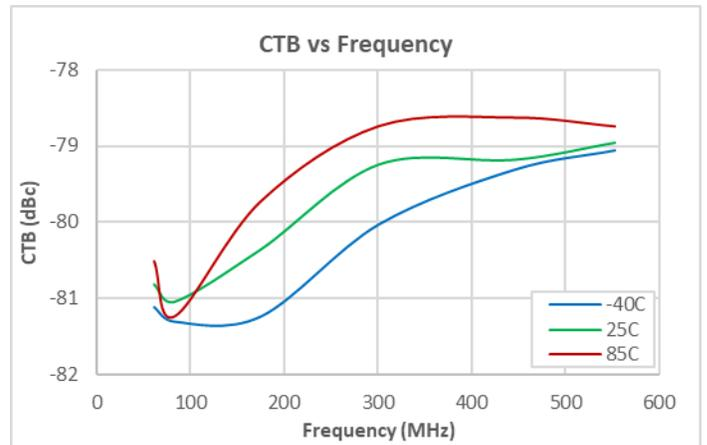
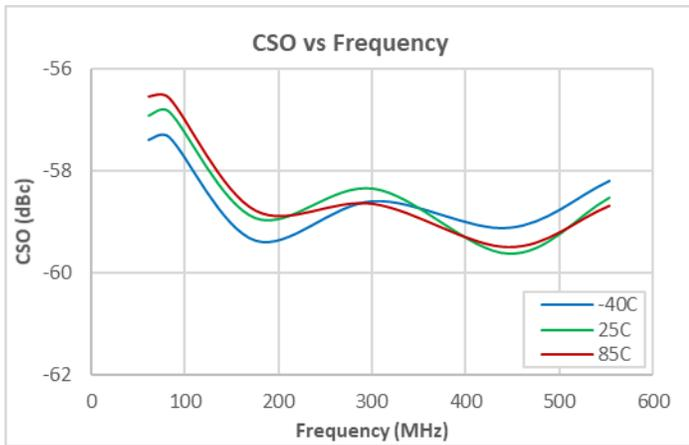
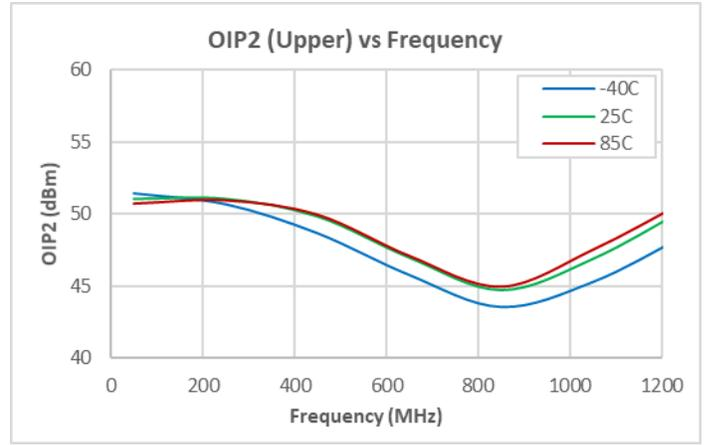
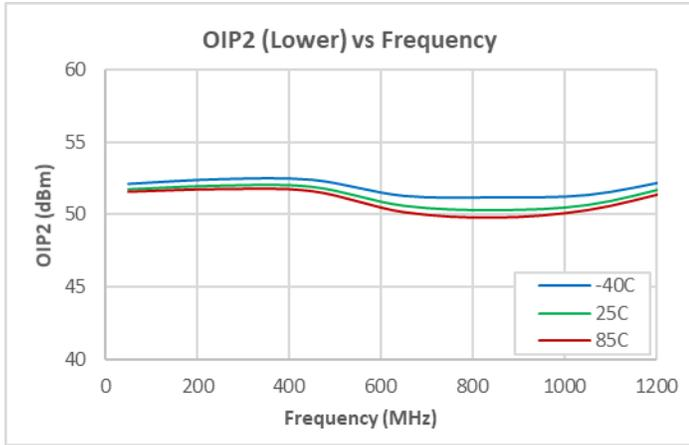

- Notes:
- (1) OIP2: 7 dBm / tone output
  - (2) CSO/CTB, CCN: 29 dBmV / ch output, 80 NTSC + 108 QAM, flat
  - (3) MER: 190 QAM256 Channels, 57-1215MHz, ITU-T J.83, Annex B

### Performance Data – 8V

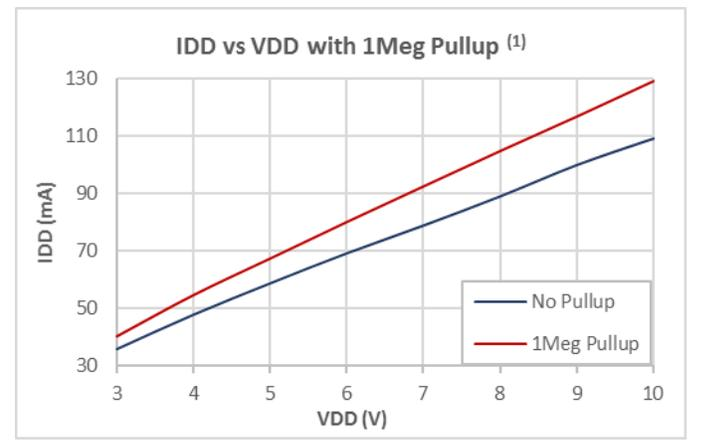
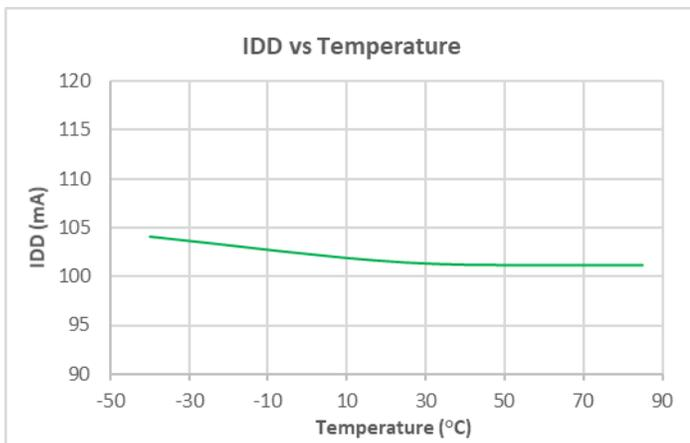
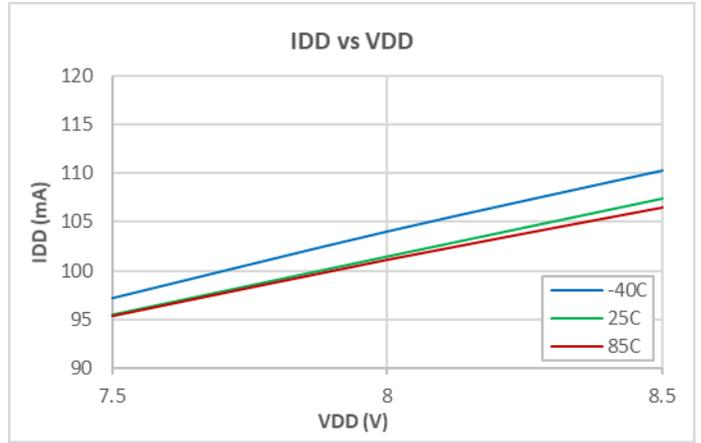
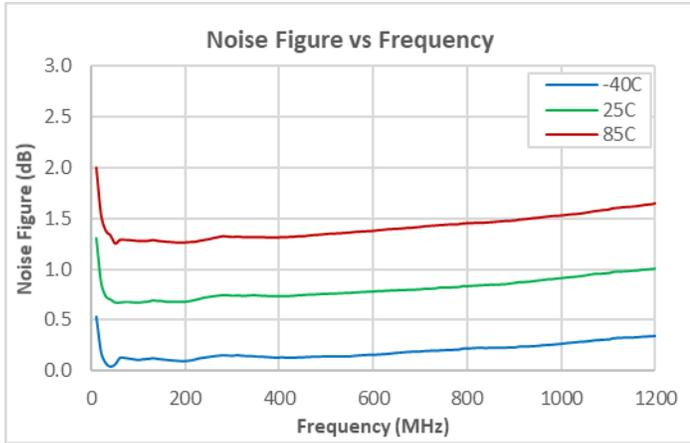

**Notes:**

(1) 1Meg Pullup installed in R3, 0  $\Omega$  installed in R5. Refer to Evaluation Board Schematic on Pg 5.

## Performance Data vs Supply Voltage

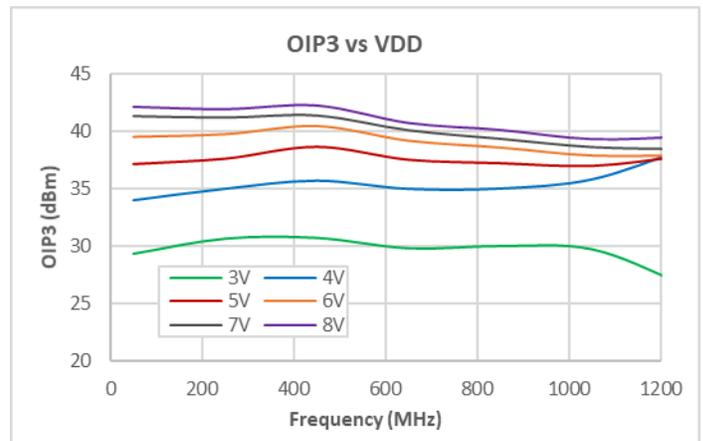
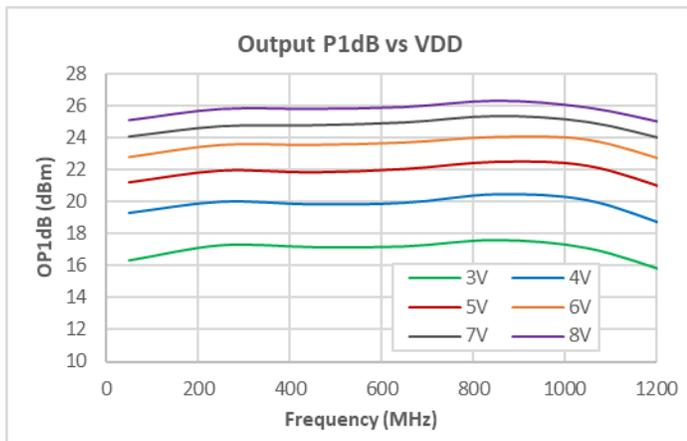
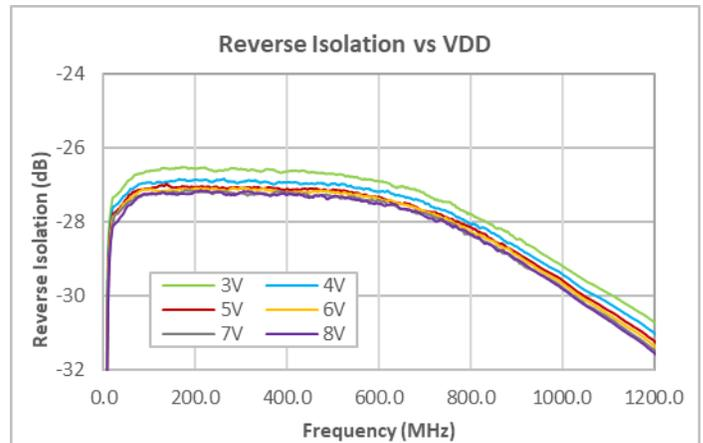
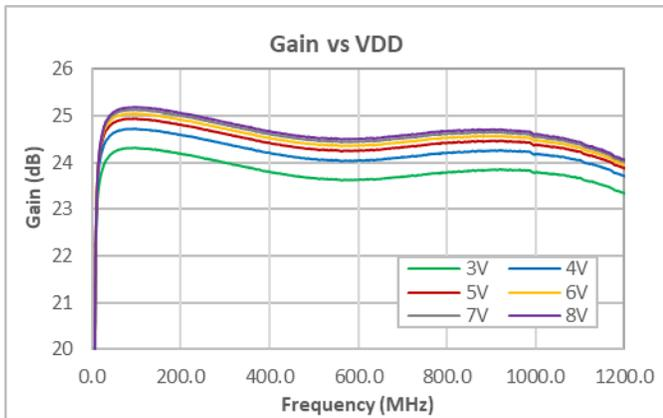
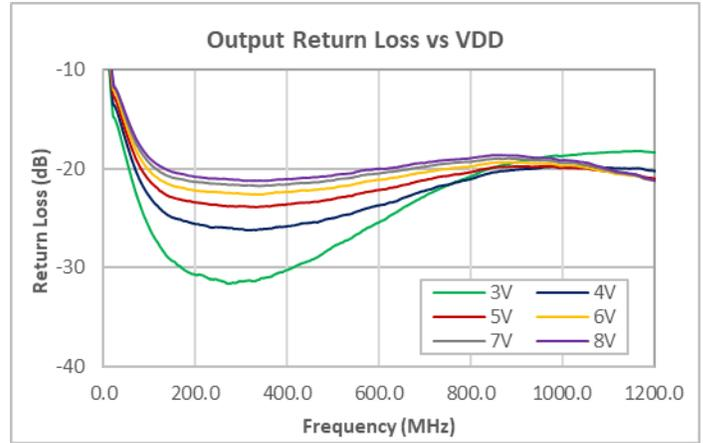
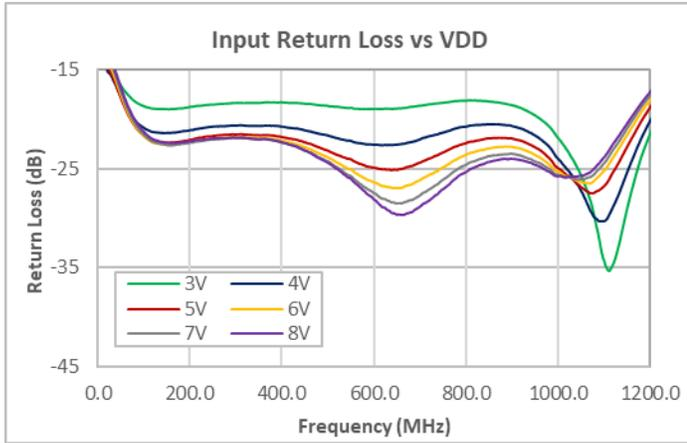

- Notes:
- (1) No pullup/pulldown resistor
  - (2) OIP3: 7 dBm / tone output

## Performance Data vs Supply Voltage

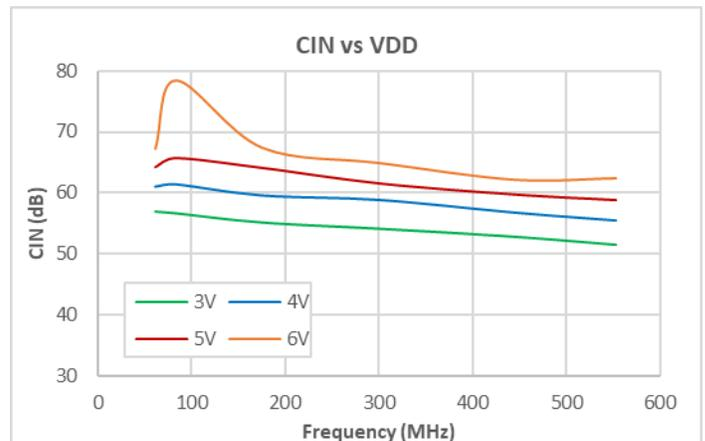
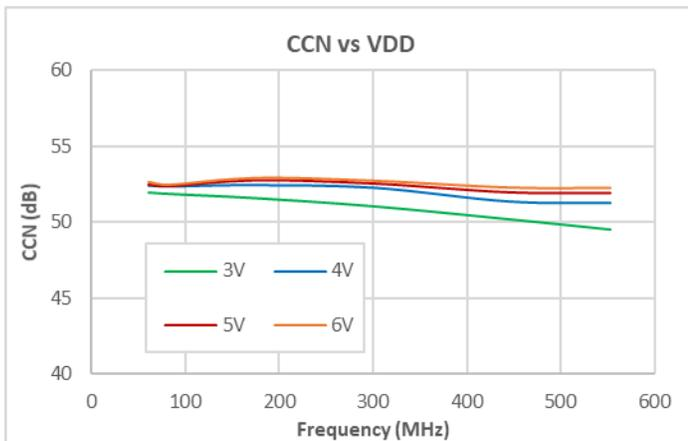
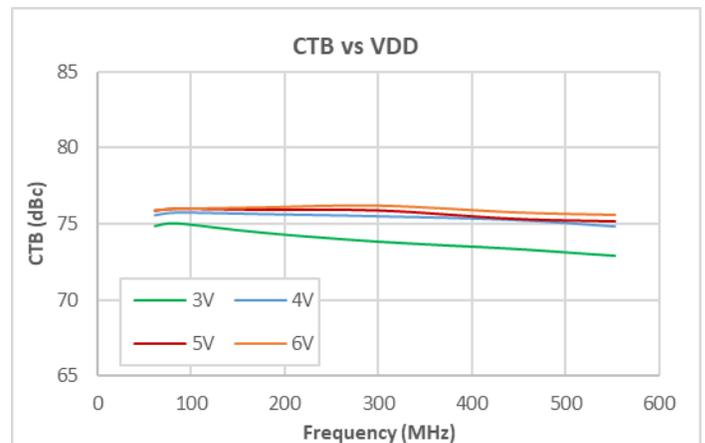
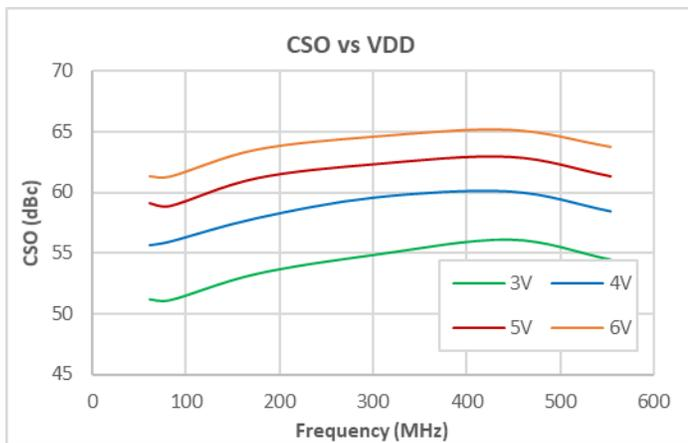
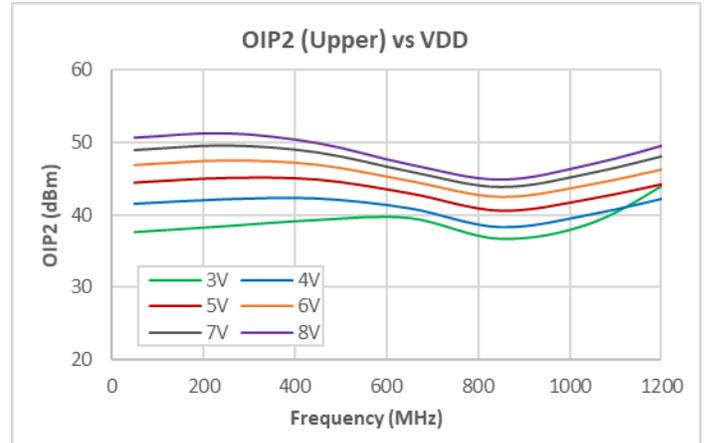
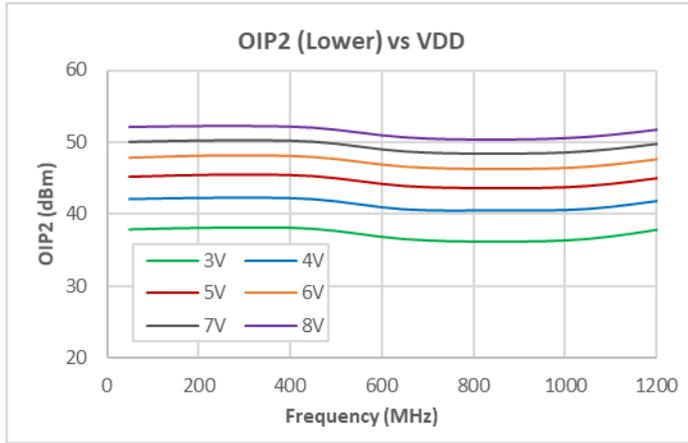

- Notes:
- (1) No pullup/pulldown resistor
  - (2) OIP2: 7 dBm/tone output
  - (3) CSO/CTB/CCN: 21 dBmV/ch output, 80 NTSC + 108 QAM, flat

## Performance Data vs Supply Voltage

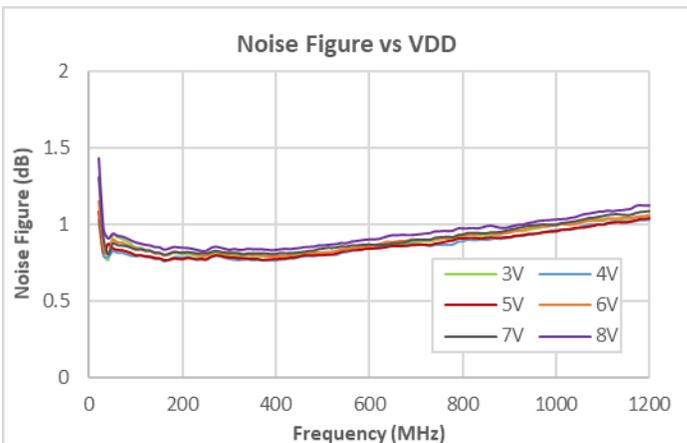
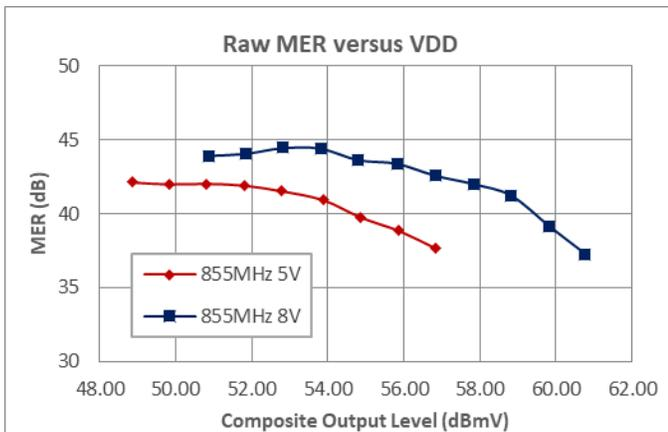
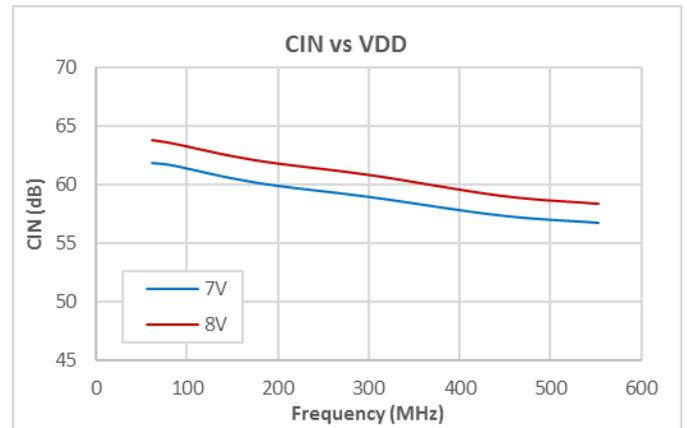
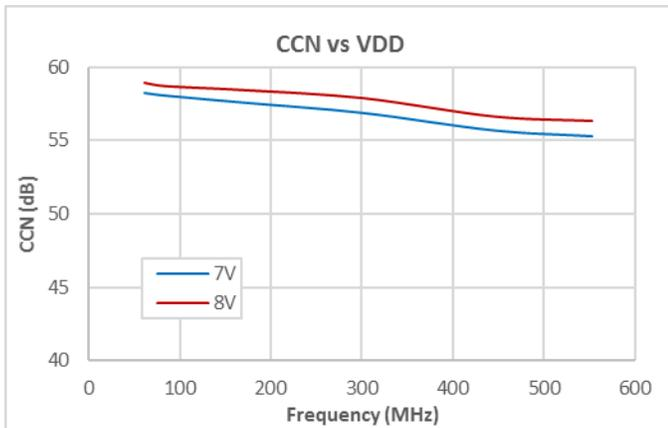
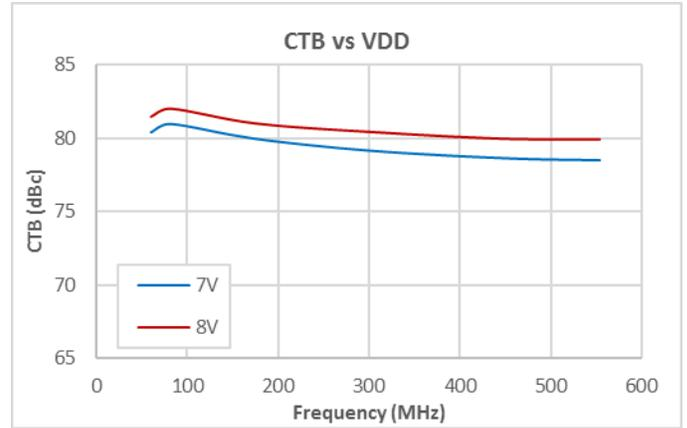
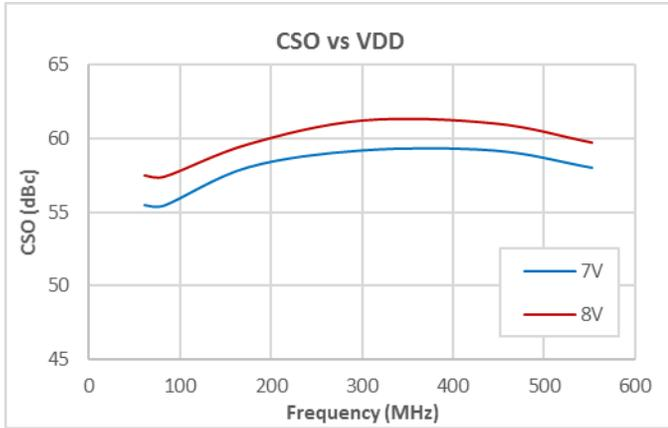

**Notes:**

- (1) No pullup/pulldown resistor
- (2) CSO/CTB/CCN: 29 dBmV / ch output, 80 NTSC + 108 QAM, flat
- (3) MER: 190 QAM256 Channels, 57-1215MHz, ITU-T J.83, Annex B

### Additional Applications

### Return Path Schematic (5 – 700MHz)

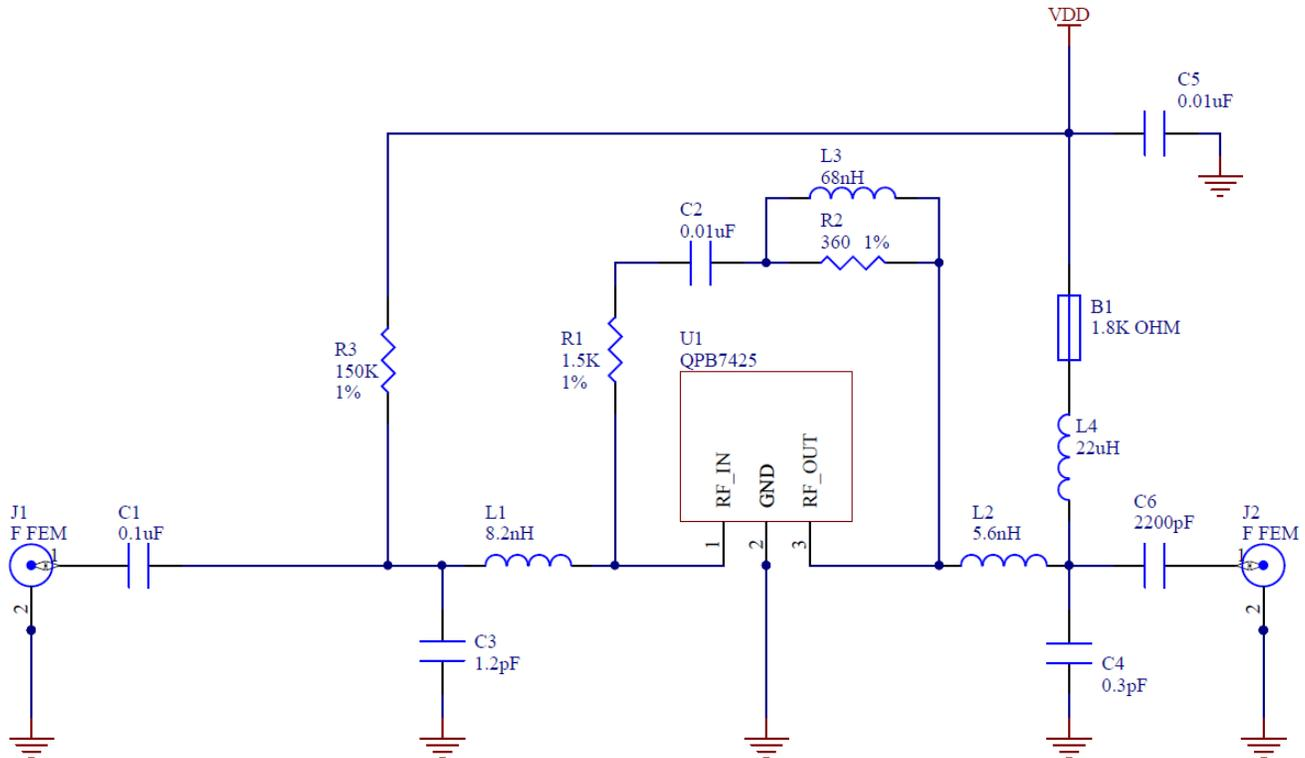

- Notes:
1. C3/L1 tunes input return loss.
  2. L2/C4 tunes output return loss with some contribution from C6.
  3. R1/L3 sets the level of feedback while B1, L4 provides the bias path with RF isolation from the RF output path.
  4. R2 helps control high end tilt/peaking.
  5. R3 increases bias current for improved linearity and NPR dynamic range. Example pullup values and bias currents are shown below.

Table 1. Return Path Pullup Resistor Options

VDD 5V				
R3	DNP	499K	150K	100K
IDD	60mA	80mA	120mA	145mA
VDD 8V				
R3	DNP	1MEG	499K	260K
IDD	90mA	100mA	120mA	145mA

Performance Data - Return Path (5-700MHz)

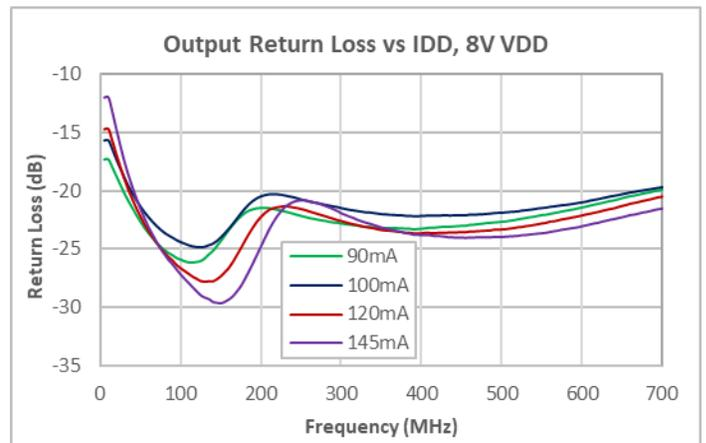
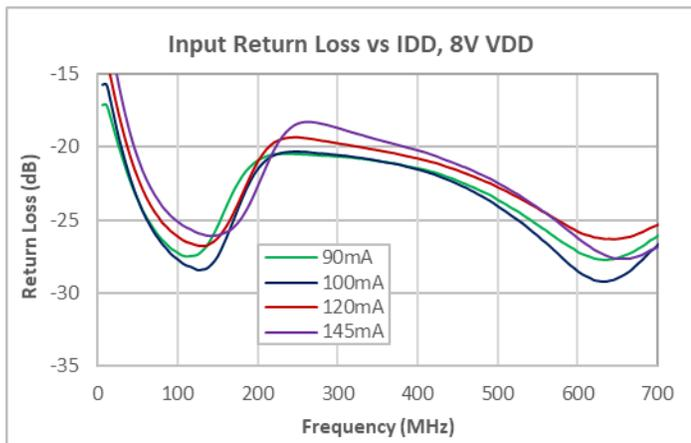
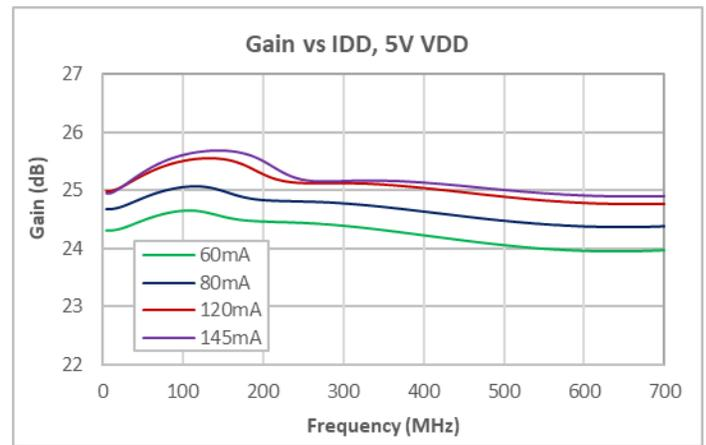
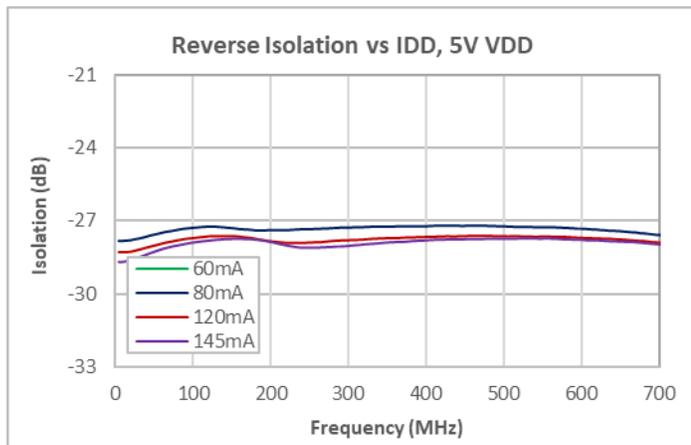
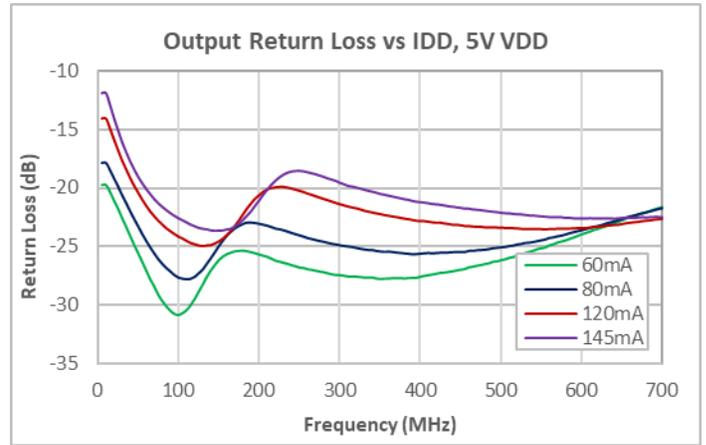
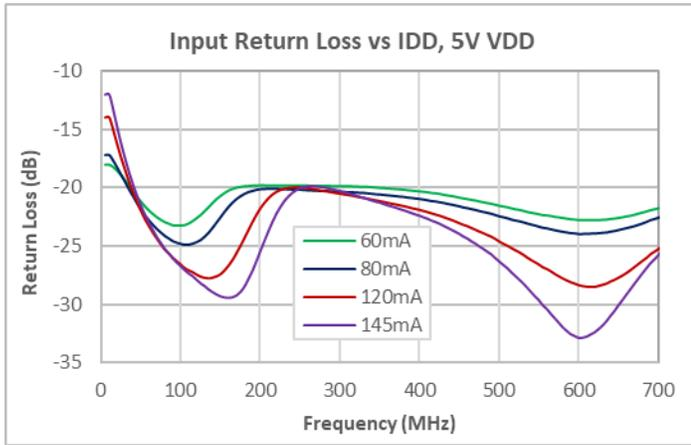

- Notes:
- (1) 25C, 75ohm test system, nominal current.
  - (2) R3 set according to Table 1 to adjust IDD

Performance Data - Return Path (5-700MHz)

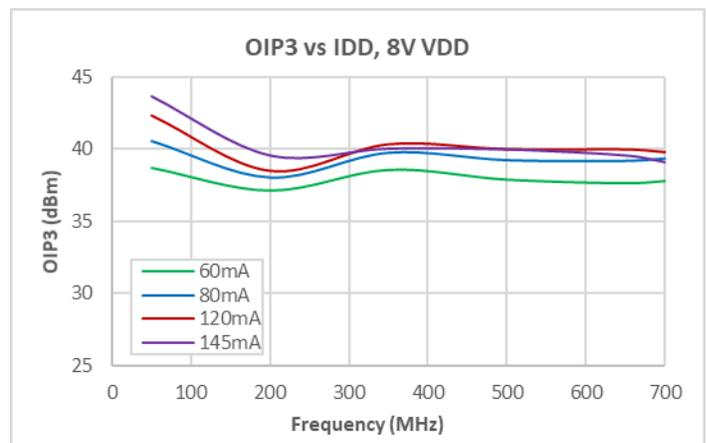
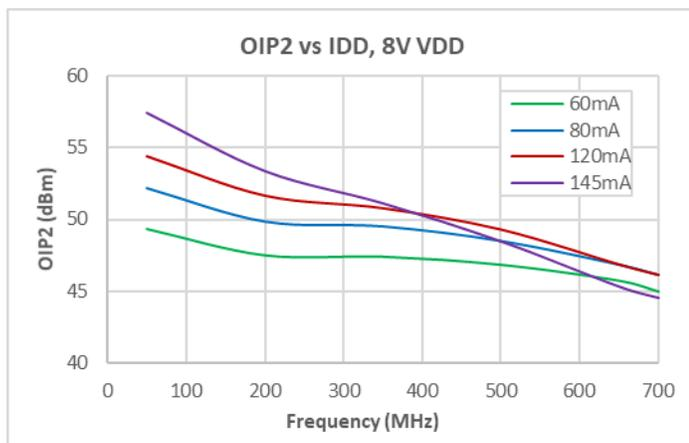
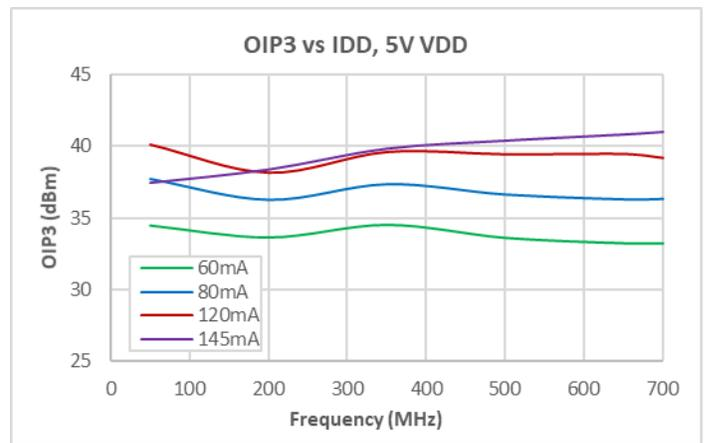
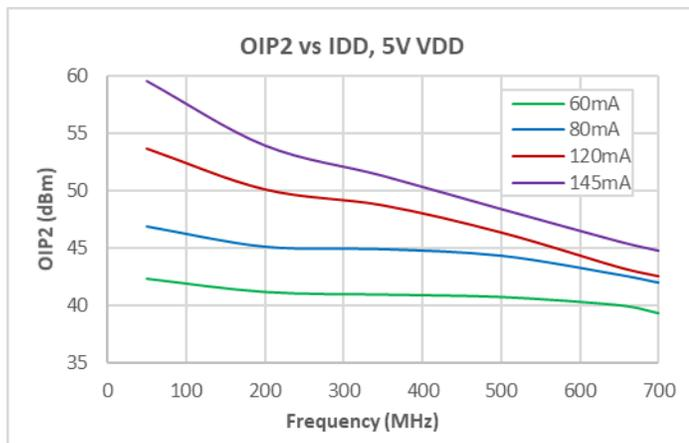
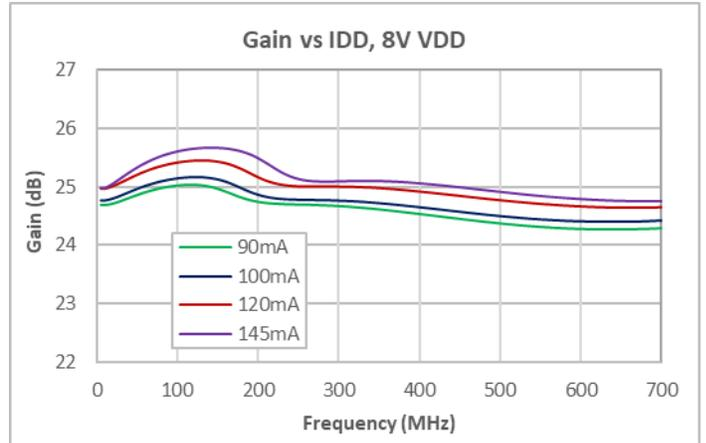
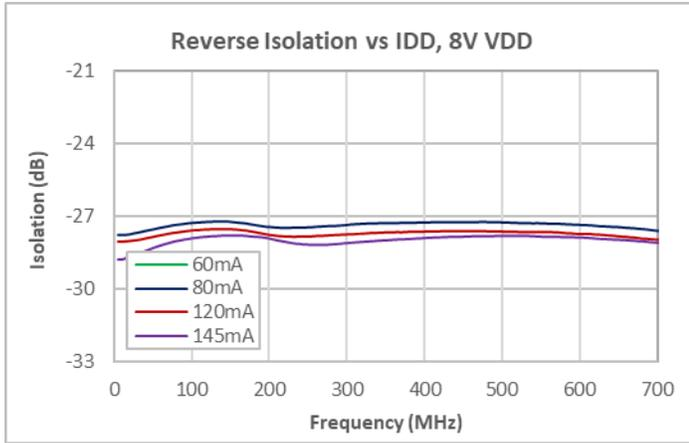

- Notes:
- (1) 25C, 75ohm test system, nominal current.
  - (2) OIP2, OIP3 tested with 7dBm per output tone
  - (3) R3 is set according to Table 1 to adjust IDD

Performance Data - Return Path (5-700MHz)

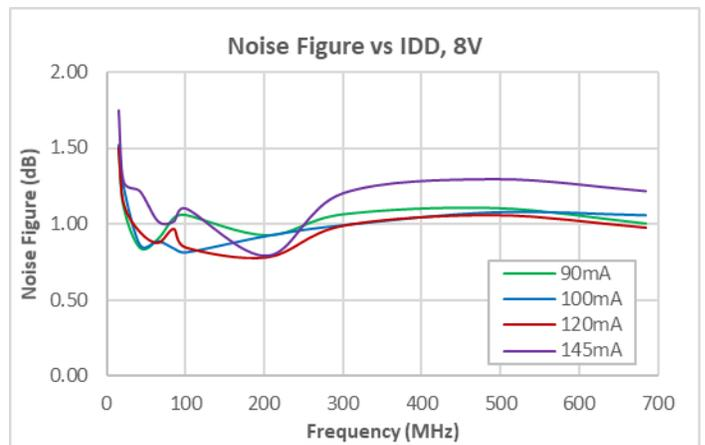
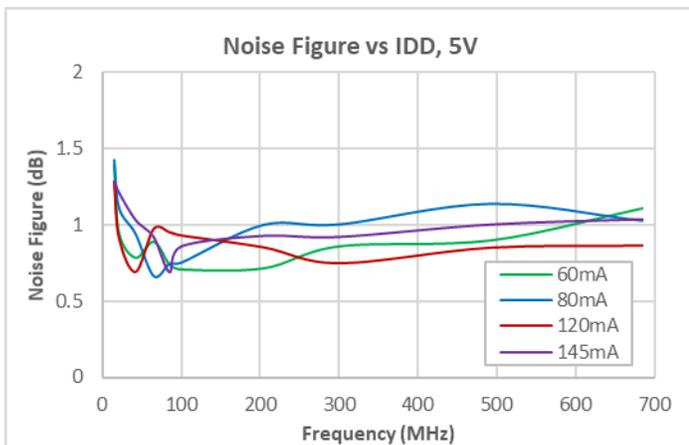
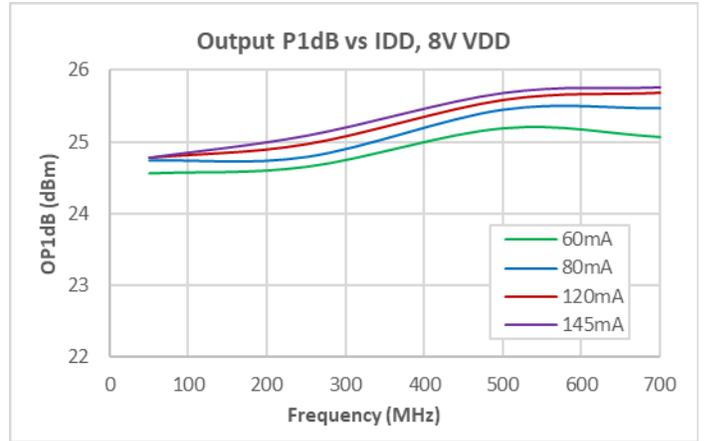
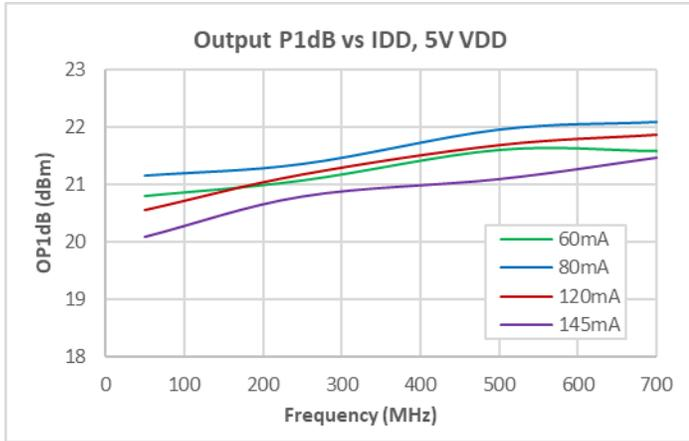

- Notes:
- (1) 25C, 75ohm test system.
  - (2) R3 set according to Table 1 to adjust IDD

Performance Data - Return Path (5-700MHz)

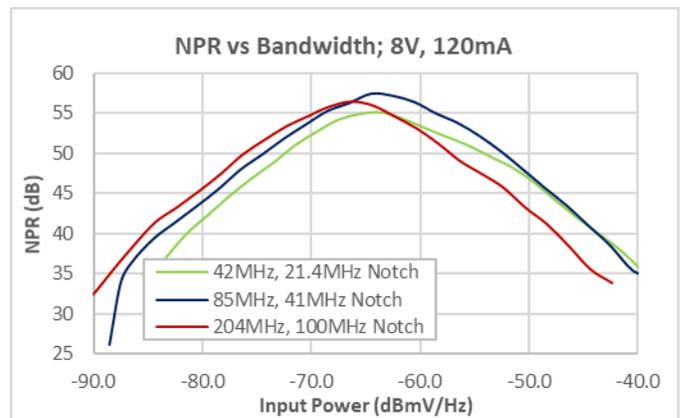
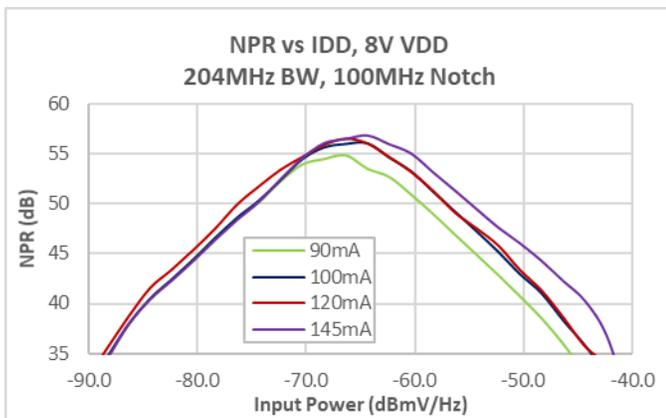
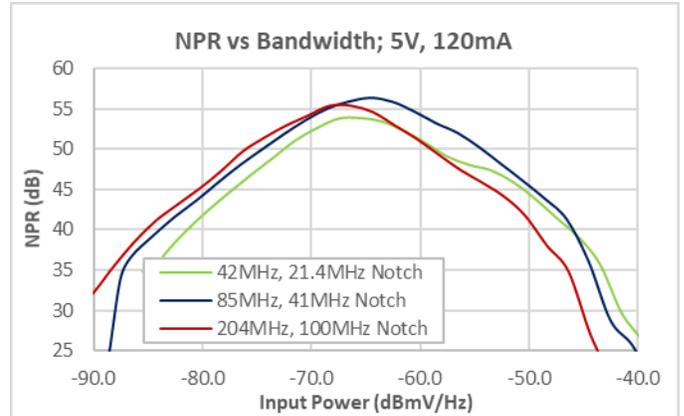
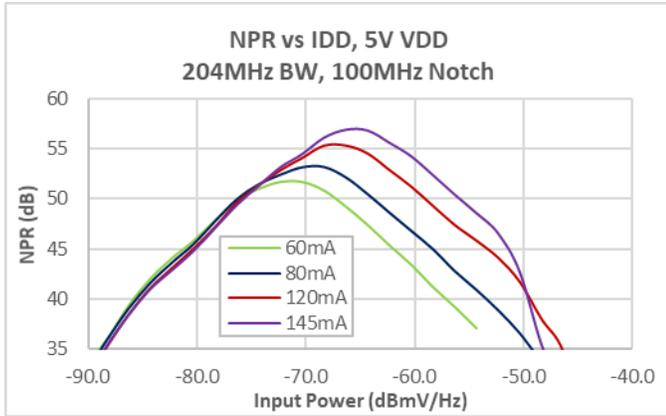

- Notes:
- (1) 25C, 75ohm test system.
  - (2) NPR tested using Applied Instruments NPRT 2200.
  - (3) R3 set according to Table 1 to adjust IDD

### 50ohm LNA Schematic (1.0 - 1.6GHz)

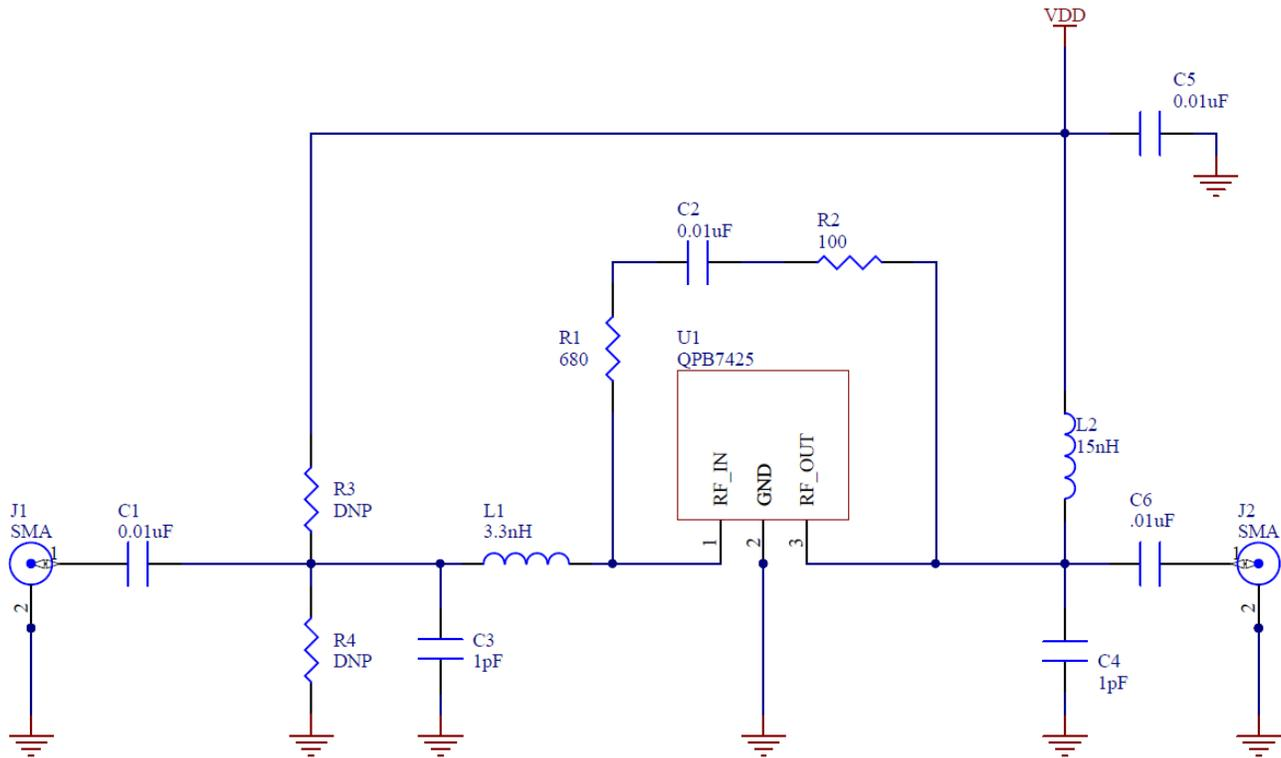

**Notes:**

- (1) C3/L1 tunes input return loss.
- (2) L2/C4 tunes output return loss with some contribution from C6.
- (3) R1/L3 sets the level of feedback while B1, B2 provides the bias path with RF isolation from the RF output path.
- (4) R2 helps control high end tilt/peaking.
- (5) R3 or R4 can be added to adjust IDD if needed (refer to Table 2 below).
- (6) Nominal current without pullup/pulldown is 31mA for 2.8V, 57mA for 5V.

Table 2: R3/R4 vs IDD

VDD	IDD						
	30mA	40mA	50mA	65mA	80mA	95mA	110mA
2.8V	open	R3 = 475K	R3 = 221K	x	x	x	x
5V	x	x	R4 = 205K	R3 = 887K	R3 = 365K	R3 = 237K	R3 = 169K

Performance Data - 50ohm LNA (1.0 – 1.6GHz, 50ohms)

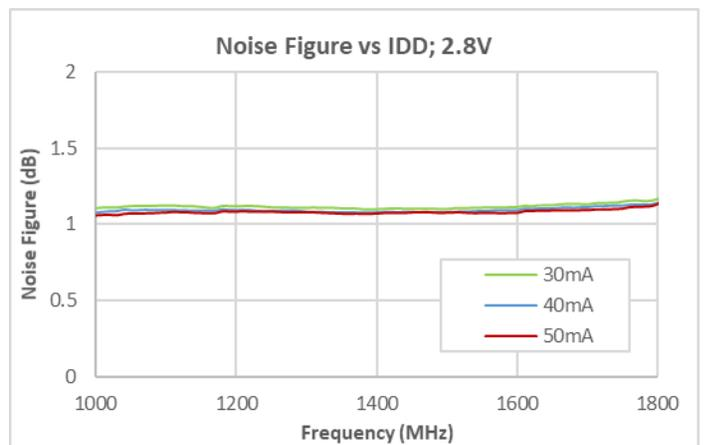
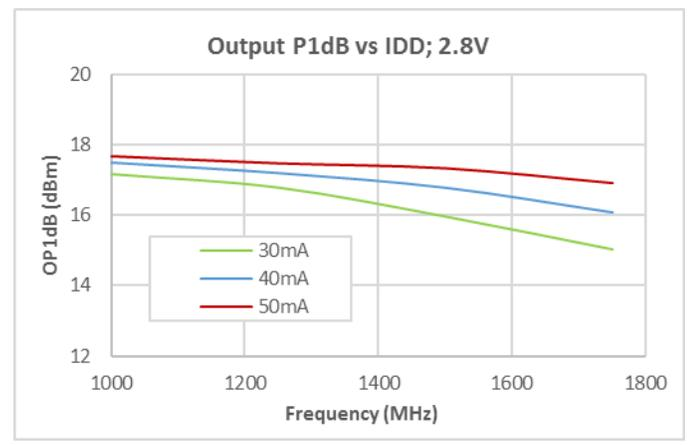
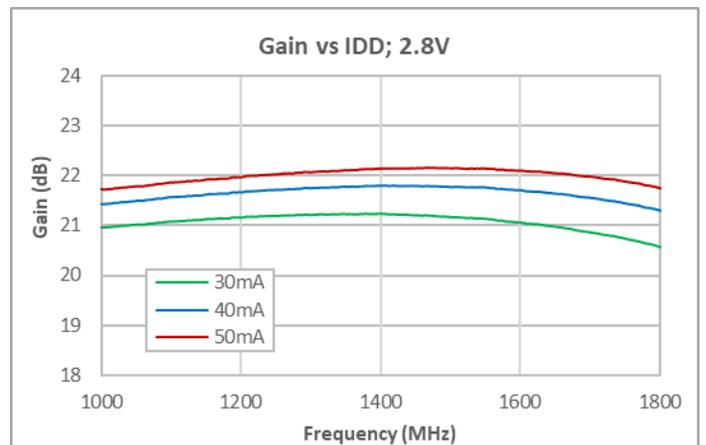
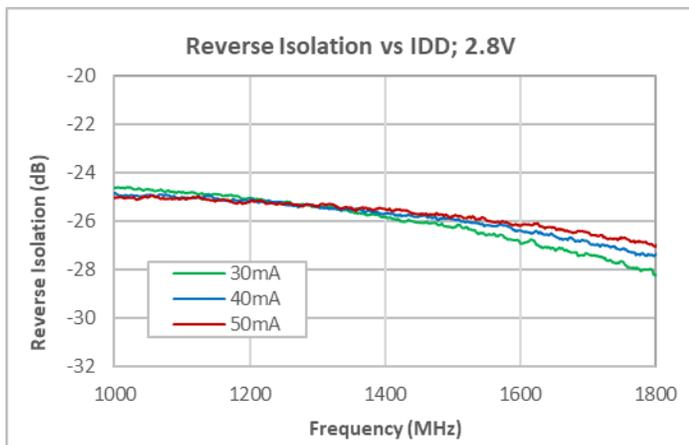
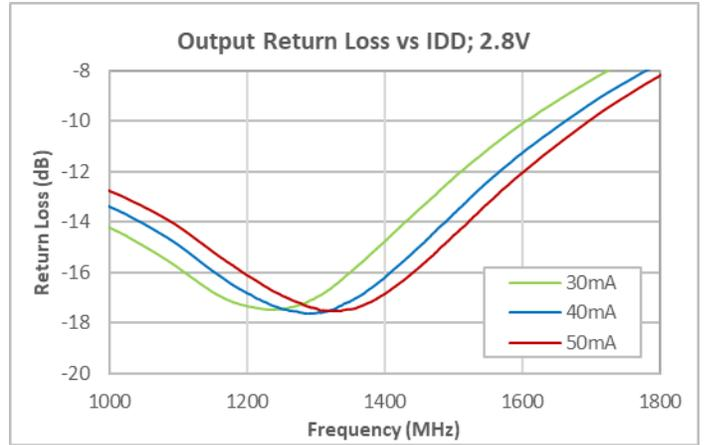
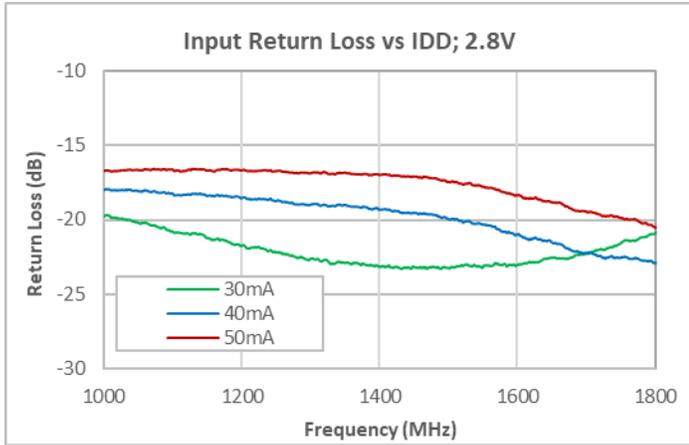

- Notes:
- (1) 25C, 50ohm test system.
  - (2) R3/R4 set according to Table 2 to adjust IDD.

Performance Data - 50ohm LNA (1.0 – 1.6GHz, 50ohms)

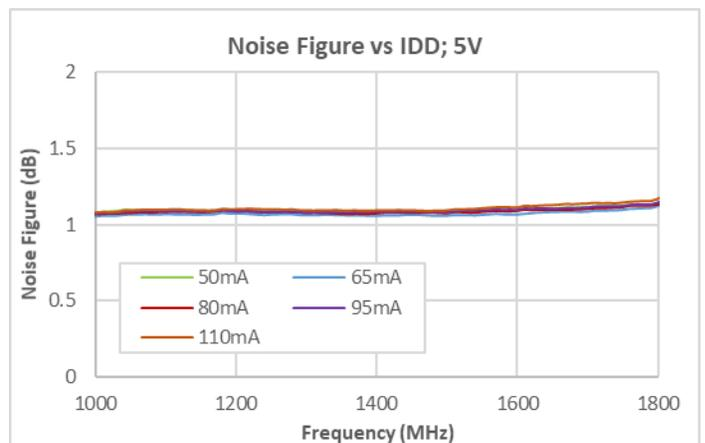
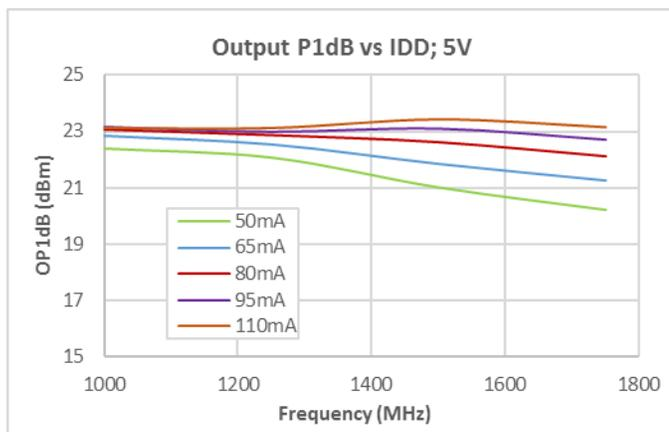
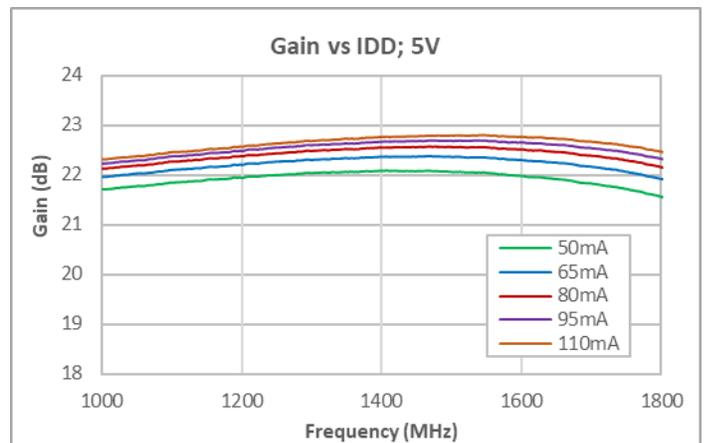
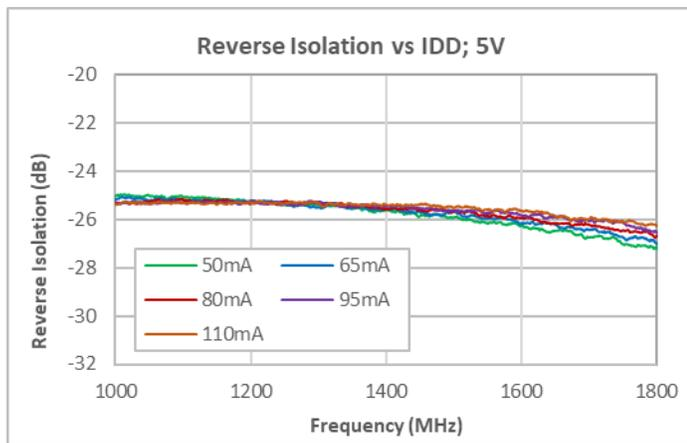
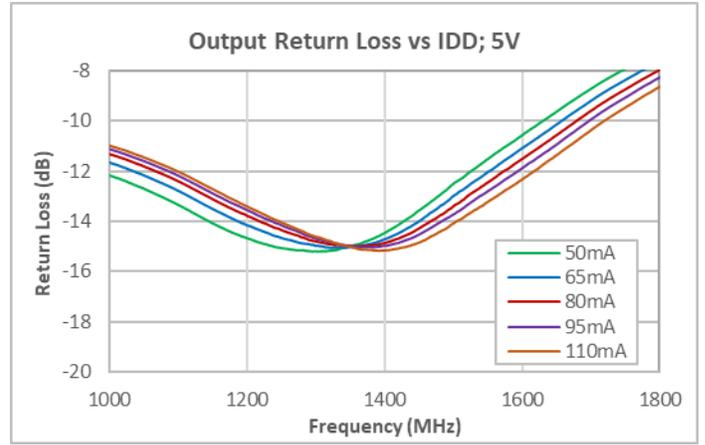

- Notes:
- (1) 25C, 50ohm test system.
  - (2) R3/R4 set according to Table 2 to adjust IDD.

## Performance Data - Pullup Resistor Options

Table 3. Pullup/Pulldown Bias Resistor Options

Bias Current vs R3/R4				
R3 Pullup (ohms)	R4 Pulldown (ohms)	IDD (8V) (mA)	IDD (5V) (mA)	IDD (3V) (mA)
100K	Open	203*	144.0	78.8
221K	Open	154.6*	96.6	54.1
499K	Open	117.1	73.9	42.4
1M	Open	102.0	64.7	38.4
Open	Open	85.1	55.6	33.3
Open	1M	84.0	55.0	32.3
Open	100K	73.6	46.6	26.3

\* Exceeds Abs. Max. Current for device

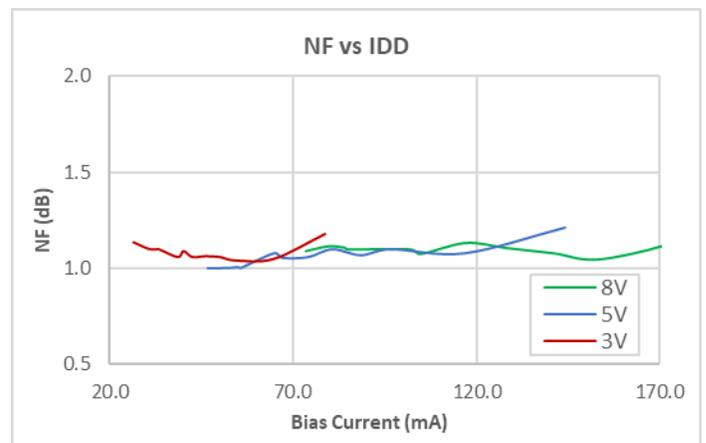
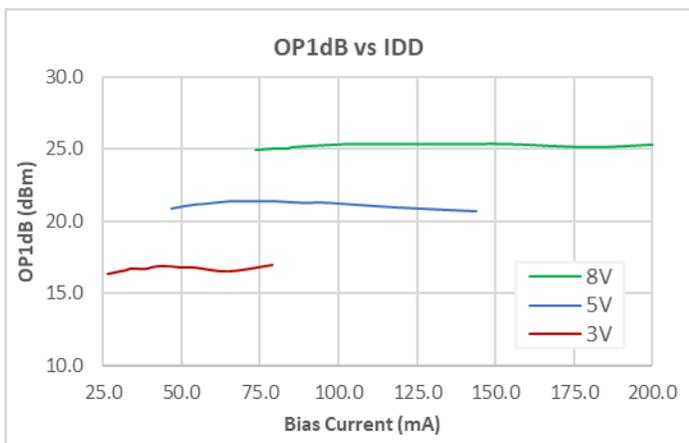
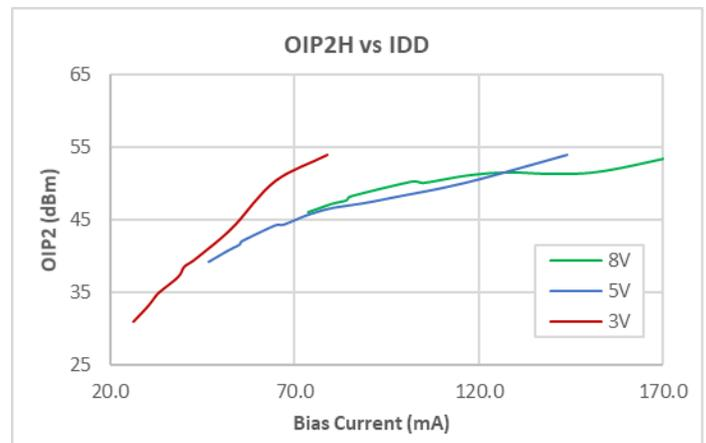
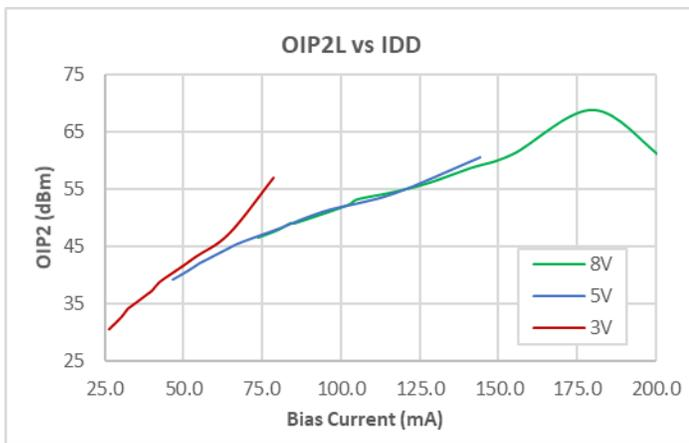
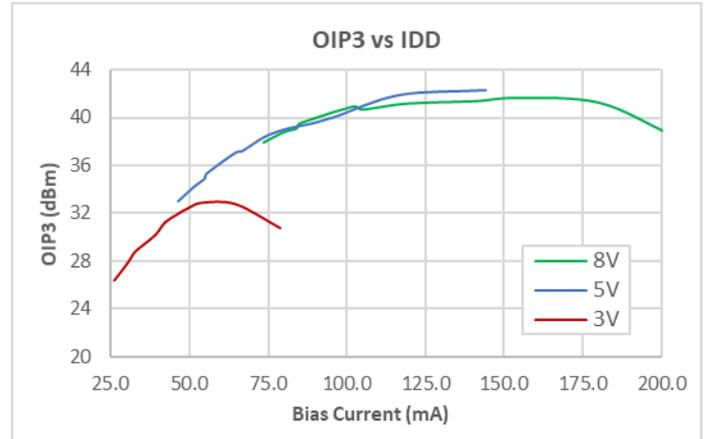
**Notes:**

- (1) OIP3, OIP2: 225MHz, 325MHz, 7 dBm/tone output. VDD as noted, 75ohm system.
- (2) OP1dB, NF: 225MHz

Performance Data - Pullup Resistor Options

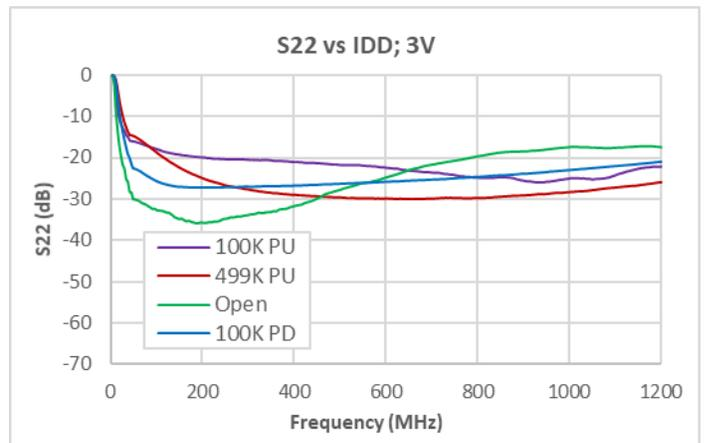
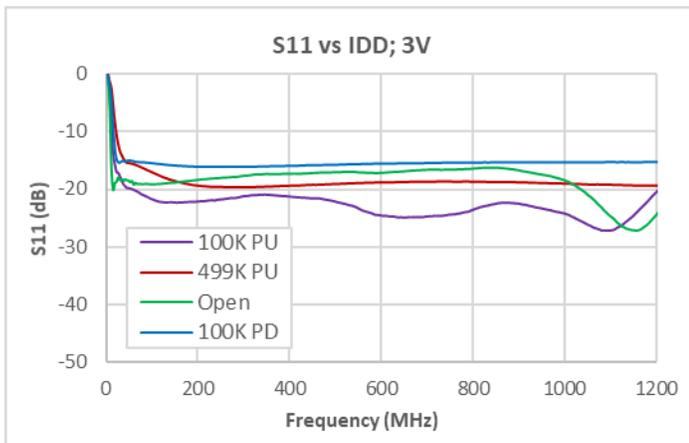
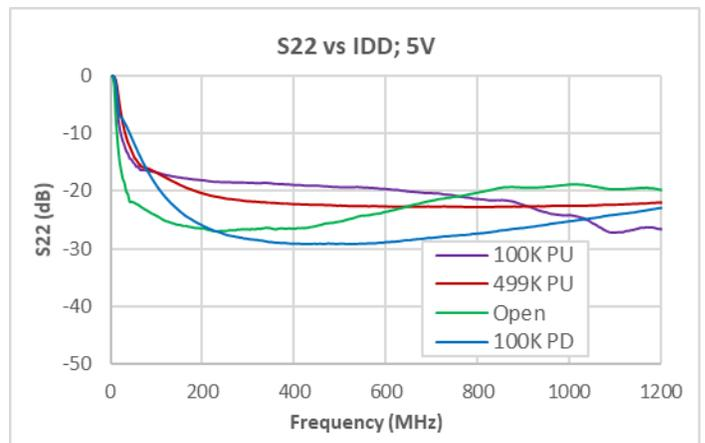
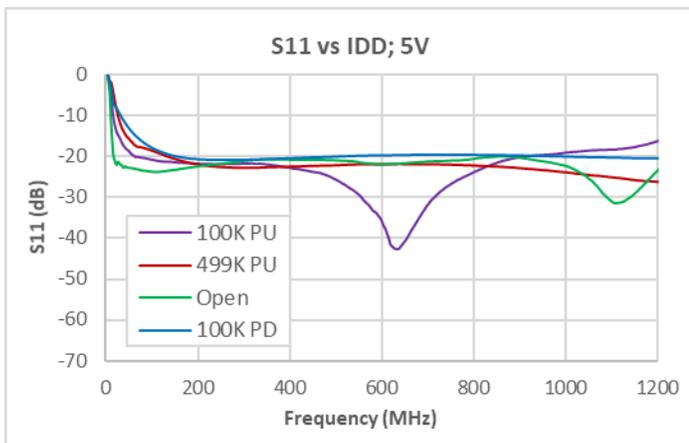
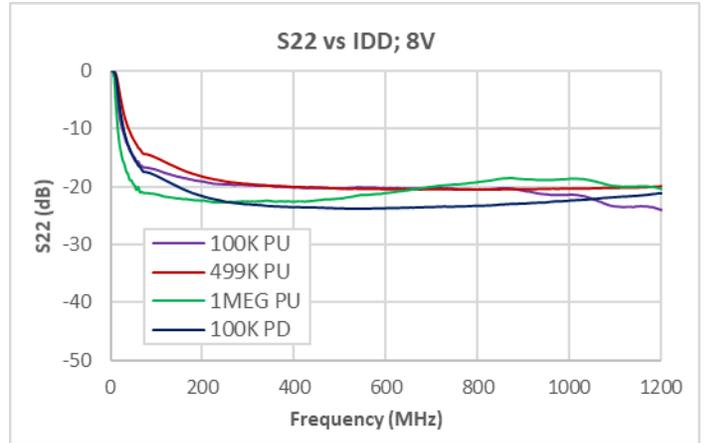
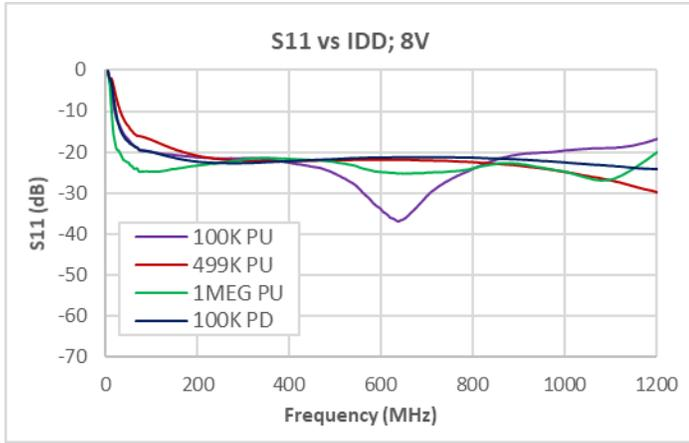

Notes:  
 (1) VDD as noted. 75ohm system.

Performance Data - Pullup Resistor Options

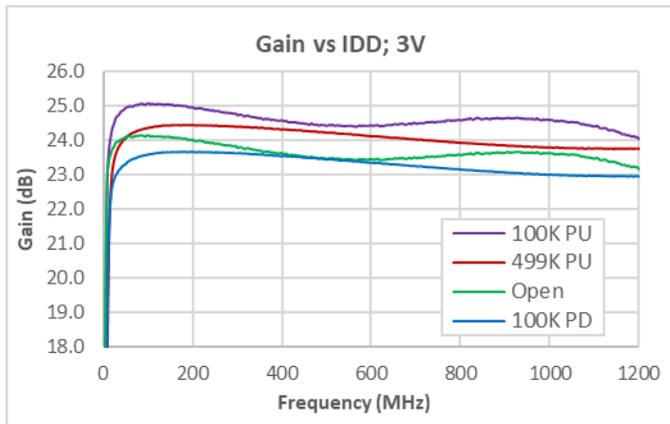
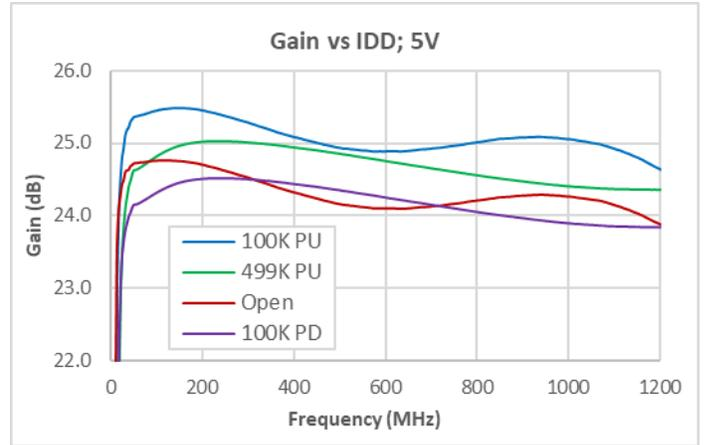
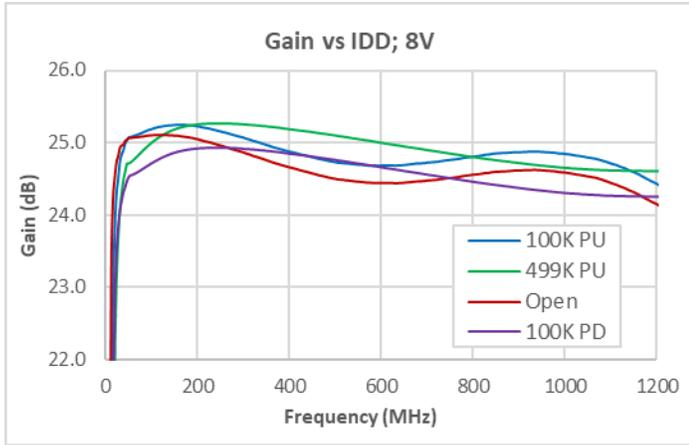

Notes:

- (1) VDD as noted. 75ohm system.

Pin Configuration and Description

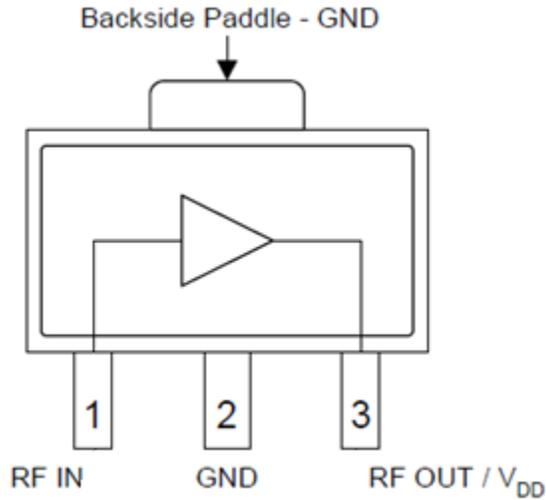

[Top View](#)

Pin No.	Label	Description
1	RF IN	RF Input, DC blocking capacitor required
2	GND	Internally Not Connected
3	RF OUT / VDD	RF Output – VDD bias choke required
Backside Paddle	GND	Ground. Use recommended via pattern to minimize inductance and thermal resistance. See PCB Mounting Pattern for suggested footprint.

#### Package Outline

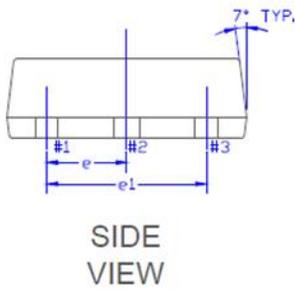
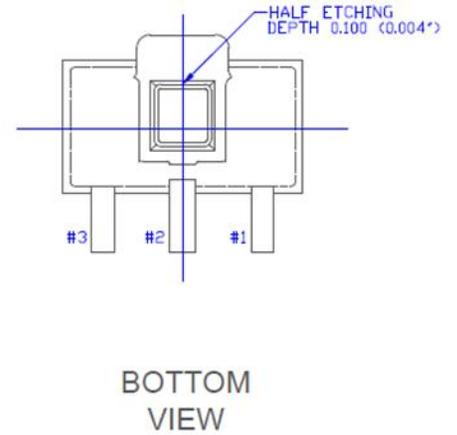
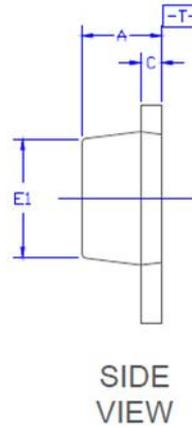
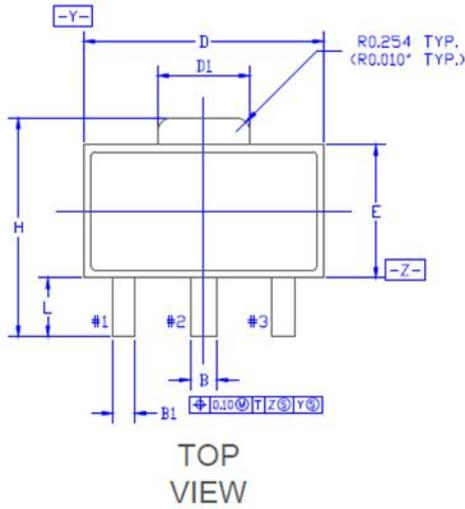

SYMBOL	Common					
	DIMENSIONS MILLIMETER			DIMENSIONS INCH		
	MIN.	NOM.	MAX.	MIN.	NOM.	MAX.
A	1.40	1.50	1.60	0.055	0.059	0.063
B	0.44	0.50	0.56	0.017	0.020	0.022
B1	0.36	0.42	0.48	0.014	0.017	0.019
C	0.35	0.40	0.44	0.014	0.016	0.017
D	4.40	4.50	4.60	0.173	0.177	0.181
D1	1.62	1.73	1.83	0.064	0.068	0.072
E	2.30	2.50	2.60	0.091	0.098	0.102
E1	2.13	2.20	2.29	0.084	0.087	0.090
e	1.50 BSC.			0.059 BSC.		
e1	3.00 BSC.			0.118 BSC.		
H	3.95	4.10	4.25	0.156	0.161	0.167
L	0.90	1.10	1.20	0.035	0.043	0.047

**Package Marking**

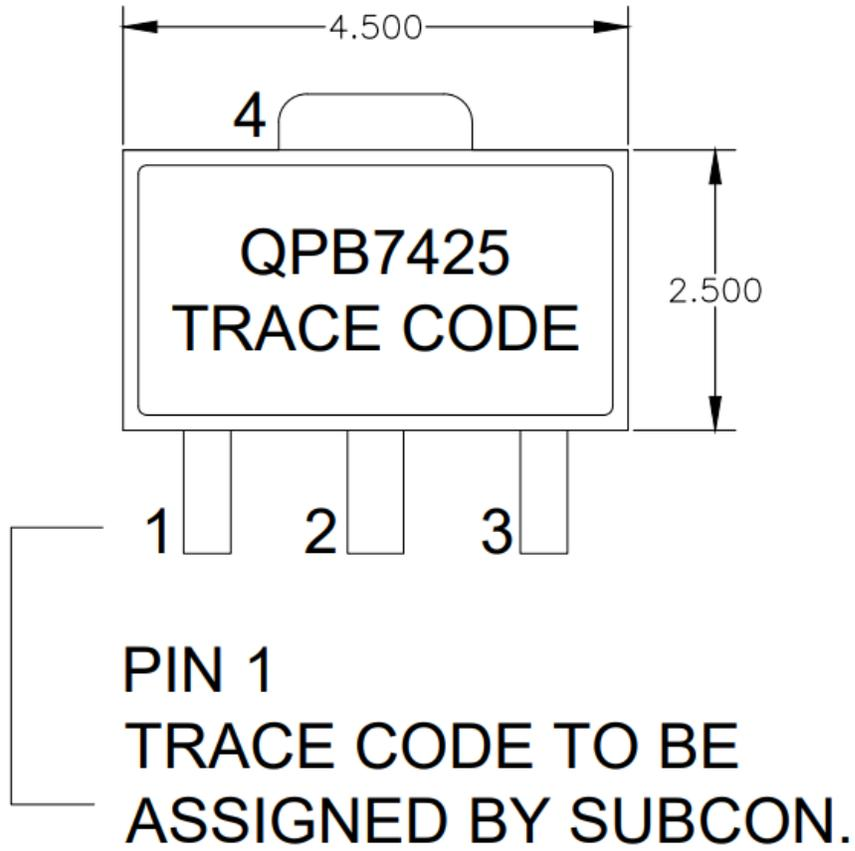

**Recommended Mounting Pattern**

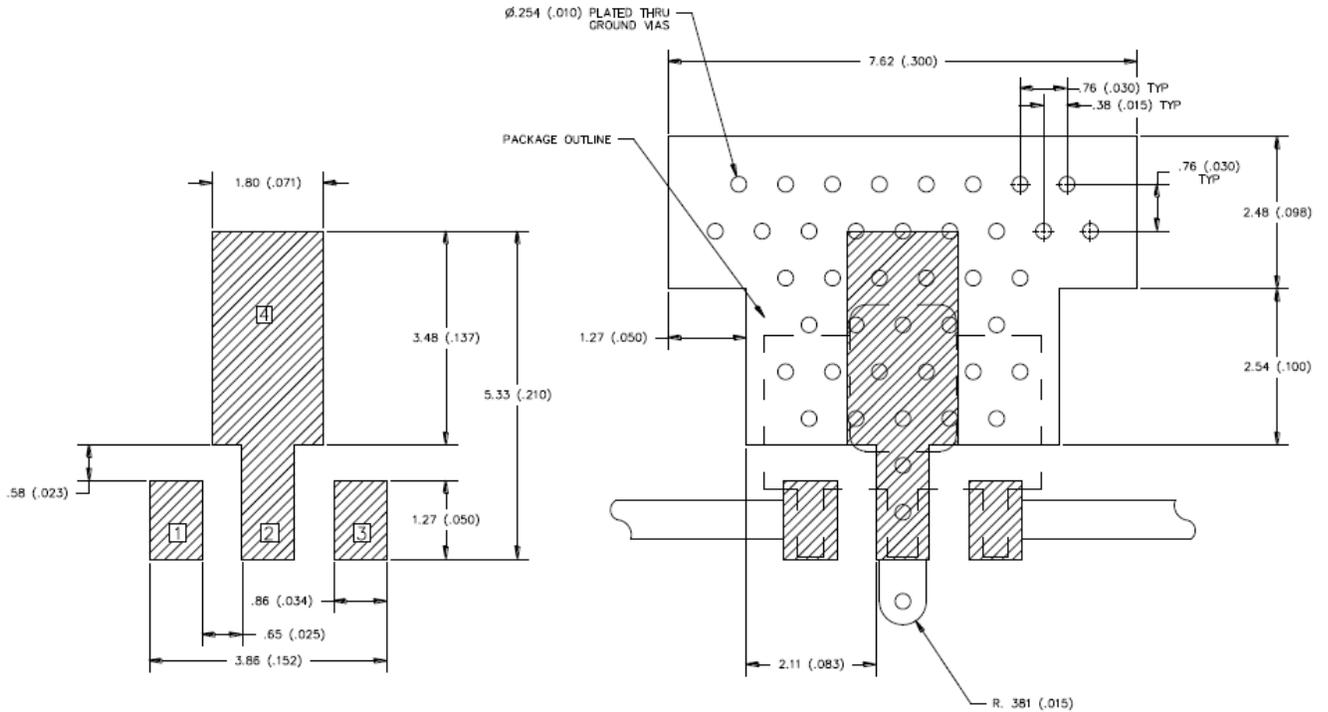

**Notes:**

- (1) Ground/thermal vias are critical for the proper performance of this device. Vias should use a .35 mm (#80/.0135") diameter drill and have a final, plated thru diameter of 0.25 mm (0.010").
- (2) Add as much copper as possible to inner and outer layers near the part to ensure optimal thermal performance.
- (3) RF trace width depends upon the PC board material and construction.
- (4) All dimensions are in millimeters (inches). Angles are in degrees.

## Handling Precautions

Parameter	Rating	Standard
ESD – Human Body Model (HBM)	1C (2000V)	ESDA / JEDEC JS-001-2012
ESD – Charged Device Model (CDM)	C3 (>1000V)	JEDEC JESD22-C101F
MSL – Moisture Sensitivity Level	Level 3	IPC/JEDEC J-STD-020



Caution!  
ESD-Sensitive Device

## Solderability

Compatible with both lead-free (260 °C max. reflow temp.) and tin/lead (245 °C max. reflow temp.) soldering processes. Solder profiles available upon request.

Contact plating: NiPdAu

## RoHS Compliance

This part is compliant with 2011/65/EU RoHS directive (Restrictions on the Use of Certain Hazardous Substances in Electrical and Electronic Equipment) as amended by Directive 2015/863/EU.

This product also has the following attributes:

- Lead Free
- Halogen Free (Chlorine, Bromine)
- Antimony Free
- TBBP-A (C<sub>15</sub>H<sub>12</sub>Br<sub>4</sub>O<sub>2</sub>) Free
- PFOS Free
- SVHC Free



## Contact Information

For the latest specifications, additional product information, worldwide sales and distribution locations:

**Tel: 1-844-890-8163**

**Web: [www.qorvo.com](http://www.qorvo.com)**

**Email: [customer.support@qorvo.com](mailto:customer.support@qorvo.com)**

## Important Notice

The information contained in this Data Sheet and any associated documents (“Data Sheet Information”) is believed to be reliable; however, Qorvo makes no warranties regarding the Data Sheet Information and assumes no responsibility or liability whatsoever for the use of said information. All Data Sheet Information is subject to change without notice. Customers should obtain and verify the latest relevant Data Sheet Information before placing orders for Qorvo® products. Data Sheet Information or the use thereof does not grant, explicitly, implicitly or otherwise any rights or licenses to any third party with respect to patents or any other intellectual property whether with regard to such Data Sheet Information itself or anything described by such information.

DATA SHEET INFORMATION DOES NOT CONSTITUTE A WARRANTY WITH RESPECT TO THE PRODUCTS DESCRIBED HEREIN, AND QORVO HEREBY DISCLAIMS ANY AND ALL WARRANTIES WITH RESPECT TO SUCH PRODUCTS WHETHER EXPRESS OR IMPLIED BY LAW, COURSE OF DEALING, COURSE OF PERFORMANCE, USAGE OF TRADE OR OTHERWISE, INCLUDING THE IMPLIED WARRANTIES OF MERCHANTABILITY AND FITNESS FOR A PARTICULAR PURPOSE. Without limiting the generality of the foregoing, Qorvo® products are not warranted or authorized for use as critical components in medical, life-saving, or life-sustaining applications, or other applications where a failure would reasonably be expected to cause severe personal injury or death. Applications described in the Data Sheet Information are for illustrative purposes only. Customers are responsible for validating that a particular product described in the Data Sheet Information is suitable for use in a particular application.

© 2021 Qorvo US, Inc. All rights reserved. This document is subject to copyright laws in various jurisdictions worldwide and may not be reproduced or distributed, in whole or in part, without the express written consent of Qorvo US, Inc. | QORVO® is a registered trademark of Qorvo US, Inc.