

■ Features

- Kyocera's series of Multilayer Ceramic Chip Capacitors are designed to meet a wide variety of needs. We offer a complete range of products for both general and specialized applications.
- We have a network worldwide in order to supply our global customer bases quickly and efficiently.
- All our products are highly reliable due to their monolithic structure of high-purity and superfine uniform ceramics and their integral internal electrodes.
- Our stringent quality control in every phase of production from material procurement to shipping ensures consistent manufacturing and superior quality.
- Kyocera components are available in a wide choice of dimensions, temperature characteristics, rated voltages, and terminations to meet specific configurational requirements.

■ KYOCERA PART NUMBER

CM **03** **X5R** **225** **M** **06** **A** **H** □□□
 ① ② ③ ④ ⑤ ⑥ ⑦ ⑧ OPTION :

Above digits are used to track individual specification or thickness.

(Example)

- ① Series : CM Series (General)
- ② Size : 0201
- ③ Dielectric : X5R
- ④ Capacitance : 2.2μF
- ⑤ Tolerance : ±20%
- ⑥ Voltage : 6.3Vdc
- ⑦ Termination : Sn
- ⑧ Packaging : Cavity pitch 2mm / Reel Size φ180

① SERIES CODE

CODE	Type
CM	General
CT	Low Profile
CU	High-Q
KNH	Three Terminal Capacitors

② SIZE CODE

CODE	EIA	JIS
02	01005	0402
03	0201	0603
05	0402	1005
105	0603	1608
21	0805	2012
316	1206	3216
32	1210	3225

③ DIELECTRIC CODE

Temperature Compensation Type			
CODE	Temperature Range (°C)	ppm/°C	
CG	-55 to 125	0	±30
CH			±60

- All parts of COG will be marked as "CG" but will conform to the above table.
- Temperature coefficients are determined by calculation based on measurement at 20°C and 85°C.

High Dielectric Constant Type			
CODE	Temperature Range (°C)	ΔC max. (%)	Standard Temperature (°C)
X5R	-55 to 85	±15	25
X6S	-55 to 105	±22	
X6T		+22/-33	
X7R		±15	
X7S	-55 to 125	±22	
X7T		+22/-33	

④ CAPACITANCE CODE

Capacitance expressed in pF.
Two significant digits plus number of zeros.
For Values < 10pF, Letter R denotes decimal point,
< 1,000pF = 1nF, 1,000nF = 1μF >

(Example)

CODE	Capacitance
R50	0.5pF
1R0	1pF
100	10pF
101	100pF
102	1nF
103	10nF
104	100nF
105	1μF
106	10μF
107	100μF

E STANDARD NUMBER					
	E3	E6	E12	E24	
1.0	1.0	1.0	1.0	1.1	
		1.2	1.2	1.3	
	1.5	1.5	1.5	1.6	
		1.8	1.8	2.0	
2.2	2.2	2.2	2.2	2.4	
		2.7	2.7	3.0	
	3.3	3.3	3.3	3.6	
		3.9	3.9	4.3	
4.7	4.7	4.7	4.7	5.1	
		5.6	5.6	6.2	
	6.8	6.8	6.8	7.5	
		8.2	8.2	9.1	

⑤ TOLERANCE CODE

Temperature Compensation Type (COG)	
CODE	Tolerance
A*	±0.05pF
B	±0.1pF
C	±0.25pF
D	±0.5pF
G*	±2%
J	±5%
K	±10%

* : Option

⑥ VOLTAGE CODE

CODE	Rated Voltage
02	2.5Vdc
04	4Vdc
06	6.3Vdc
10	10Vdc
16	16Vdc
25	25Vdc
35	35Vdc
50	50Vdc
100	100Vdc

⑦ TERMINATION CODE

CODE	Termination
A	Nickel Barrier/ Tin

* Please contact us if Au termination is needed.

⑧ PACKAGING CODE

CODE	Size Code	Cavity pitch	Reel size
T	105 to 32	4mm	φ180
H	02 to 05	2mm	
Q	03/05	1mm	
P	02	1mm	
L	105 to 32	4mm	φ330
N	02 to 05	2mm	
W	03/05	1mm	

High Dielectric Constant Type (X5R/X6S/X6T/X7R/X7S/X7T)	
CODE	Tolerance
J*	±5%
K	±10%
M	±20%

* : Option



Dimension

■CM/CT/CU Series

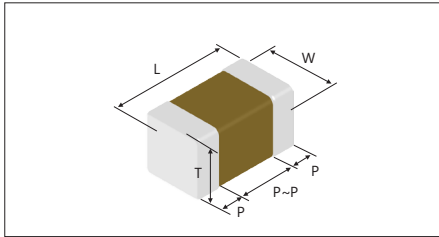

■Packaging Code

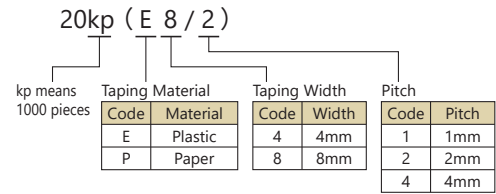

Size	Code		Dimension Code	Dimension (mm)						Quantity per reel	
	EIA	JIS		L	W	T	P min.	P max.	P to P min.	φ180 Reel	φ330 Reel
02	01005	0402	A	0.4±0.02	0.2±0.02	0.2±0.02	0.07	0.14	0.13	40kp(E4/1) 20kp(P8/2)	— 80kp(P8/2)
03	0201	0603	A	0.6±0.03	0.3±0.03	0.22 max.	0.1	0.2	0.2	30kp(P8/1) 15kp(P8/2)	150kp(P8/1) 50kp(P8/2)
			B			0.3±0.03					
			C	0.6±0.05	0.3±0.05	0.3±0.05	0.13	0.23	0.19	15kp(P8/2)	50kp(P8/2)
			D			0.22 max.					
			E			0.3±0.09					
F	0.5±0.05	—									
05	0402	1005	A	1.0±0.05	0.5±0.05	0.22 max.	0.15	0.35	0.3	20kp(P8/1) 10kp(P8/2)	100kp(P8/1) 50kp(P8/2)
			B			0.33 max.					
			C			0.5±0.05					
			D	1.0±0.1	0.5±0.05	0.22 max.	0.15	0.35	0.3	10kp(P8/2)	50kp(P8/2)
			E			0.5±0.15					
			F	1.0±0.2	0.5±0.2	0.33 max.	0.15	0.35	0.3	10kp(P8/2)	—
			G			0.5 max.					
			H			0.55 max.					
			J			0.5±0.2					
			K	0.8 max.	—						
105	0603	1608	A	1.6±0.1	0.8±0.1	0.55 max.	0.2	0.6	0.5	4kp(P8/4)	10kp(P8/4)
B	0.8±0.1										
C	0.8±0.15										
D	0.8±0.2										
21	0805	2012	B	2.0±0.1	1.25±0.1	1.25±0.1	0.2	0.75	0.7	3kp(E8/4) 4kp(P8/4)	10kp(E8/4) 10kp(P8/4)
			C			0.95 max.					
			E	2.0±0.2	1.25±0.2	0.95 max.	0.2	0.75	0.7	4kp(P8/4)	10kp(P8/4)
			F			1.25±0.2					
316	1206	3216	A	3.2±0.2	1.6±0.15	1.6±0.15	0.3	0.85	1.4	2.5kp(E8/4)	5kp(E8/4)
B	1.6±0.2										
C	1.6±0.2										
32	1210	3225	A	3.2±0.3	2.5±0.2	2.5±0.2	0.3	1.0	1.4	1kp(E8/4)	4kp(E8/4)

■KNH Series

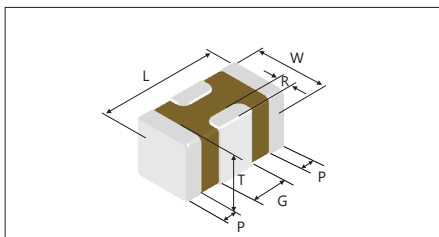

Size	Code		Dimension Code	Dimension (mm)						Packaging	
	EIA	JIS		L	W	T	G	P	R	φ180 Reel	φ330 Reel
KNH 05	0402	1005	A	1.0±0.1	0.5±0.2	0.5 max.	0.3±0.1	0.15±0.1	≥0.05	10kp(P8/2)	—
			B	1.0±0.15	0.5±0.15	0.5±0.15					
			C	1.0±0.2	0.5±0.2	0.5±0.2					



■ Features

Ultra-miniature size (0.4x0.2mm)
Low loss characteristics suitable for high frequency

■ Applications

●RF power amplifier for mobiles such as impedance matching purpose.

Temperature Compensation Dielectric

●Capacitance chart Standard Spec.1

Size (EIA Code)	Capacitance	CU02 (01005)	
		16	25
R20	0.2 pF		
R50	0.5 pF		
1R0	1 pF		
1R5	1.5 pF		
2R0	2 pF		
3R0	3 pF		
4R0	4 pF		A
5R0	5 pF	A	
6R0	6 pF		
7R0	7 pF		
8R0	8 pF		
9R0	9 pF		
100	10 pF		
120	12 pF		
150	15 pF		
180	18 pF		
220	22 pF		
240	24 pF		

<Standard Capacitor Value : E12 Series>

Please contact for capacitance value other than standard.

Please refer to [here](#) for the test method and specifications of Standard Specification 1.

Alphabets in capacitance chart denote dimensions. Please refer to the below table for detail.

(Example) In case of "A" for CU02;

L : 0.4±0.02mm, W : 0.2±0.02mm, T : ±0.02mm

Size	Dimension Code	Dimension (mm)			Packaging									
					φ180 Reel					φ330 Reel				
		L	W	T	Code	Quantity	Taping Material	Taping Width	Cavity Pitch	Code	Quantity	Taping Material	Taping Width	Cavity Pitch
02	A	0.4±0.02	0.2±0.02	0.2±0.02	P	40,000	Plastic	4mm	1mm	—	—	—	—	—
					H	20,000	Paper	8mm	2mm	N	80,000	Paper	8mm	2mm



Test Conditions and Standards

Test Conditions and Specifications for Temperature Compensation Type (CA Characteristics) CM / CU Series (Standard Spec.1)

Test Items		Test Conditions	Specifications									
Capacitance Value (C)			Within tolerance									
Q		<table border="1"> <thead> <tr> <th>Capacitance</th> <th>Frequency</th> <th>Volt</th> </tr> </thead> <tbody> <tr> <td>C ≤ 1000pF</td> <td>1MHz ± 10%</td> <td rowspan="2">0.5 to 5Vrms</td> </tr> <tr> <td>C > 1000pF</td> <td>1kHz ± 10%</td> </tr> </tbody> </table>	Capacitance	Frequency	Volt	C ≤ 1000pF	1MHz ± 10%	0.5 to 5Vrms	C > 1000pF	1kHz ± 10%	C ≥ 30pF : Q ≥ 1000 C < 30pF : Q ≥ 400 + 20C	
Capacitance	Frequency	Volt										
C ≤ 1000pF	1MHz ± 10%	0.5 to 5Vrms										
C > 1000pF	1kHz ± 10%											
Insulation Resistance (IR)		Apply the rated voltage for 1 minute, and measure it in normal temperature and humidity. The charge and discharge current of the capacitor must not exceed 50mA.	Over 10000MΩ or 500MΩ·μF, whichever is less									
Dielectric Resistance		Apply *3 times of the rated voltage for 1 to 5 seconds. *CU02CA2R20-120/25V: twice The charge and discharge current of the capacitor must not exceed 50mA.	No problem observed									
Appearance		Microscope	No problem observed									
Termination Strength		Apply a sideward force of 500g (5N) to a PCB-mounted sample. note: 2N for 0201 size, and 1N for 01005 size.	No problem observed									
Bending Strength		Glass epoxy PCB: Fulcrum spacing: 90mm, duration time 10 seconds.	No significant damage with 1mm bending.									
Vibration Test	Appearance	Vibration frequency: 10 to 55 (Hz) Amplitude: 1.5mm Sweeping condition: 10→55→10Hz/ 1 minute in X, Y and Z directions: 2 hours each, 6 hours in total.	No problem observed									
	ΔC		Within Tolerance									
	Q		C ≥ 30pF : Q ≥ 1000 C < 30pF : Q ≥ 400 + 20C									
Soldering Heat Resistant	Appearance	Soak the sample in 260°C ± 5°C solder for 10 ± 0.5 seconds and place in normal temperature and humidity, and measure the sample after 24 ± 2 hours. (Pre-heating conditions)	No problem observed									
	ΔC		Within ± 2.5% or ± 0.25pF, whichever is larger									
	Q		C ≥ 30pF : Q ≥ 1000 C < 30pF : Q ≥ 400 + 20C									
	IR		Over 10000MΩ or 500MΩ·μF whichever is less									
	Withstanding Voltage		Resist without problem									
Solderability		Soaking condition	Solder coverage : 95% min.									
		<table border="1"> <thead> <tr> <th>Order</th> <th>Temperature</th> <th>Time</th> </tr> </thead> <tbody> <tr> <td>1</td> <td>80 to 100°C</td> <td>2 minutes</td> </tr> <tr> <td>2</td> <td>150 to 200°C</td> <td>2 minutes</td> </tr> </tbody> </table>	Order	Temperature	Time	1	80 to 100°C	2 minutes	2	150 to 200°C	2 minutes	
Order	Temperature	Time										
1	80 to 100°C	2 minutes										
2	150 to 200°C	2 minutes										
Temperature Cycle	Appearance	(Cycle) Room temperature (3 min.) → Lowest operation temperature (30 min.) → Room temperature (3 min.) → Highest operation temperature (30 min.) After 5 cycles, measure after 24 ± 2 hours. The charge and discharge current of the capacitor must not exceed 50mA for IR and withstanding voltage measurement.	No problem observed									
	ΔC		Within ± 2.5% or ± 0.25pF, whichever is larger									
	Q		C ≥ 30pF : Q ≥ 1000 C < 30pF : Q ≥ 400 + 20C									
	IR		Over 10000MΩ or 500MΩ·μF, whichever is less									
	Withstanding Voltage		Resist without problem									
Moisture Resistant Load	Appearance	After applying the rated voltage for 500 + 12 / - 0 hours in the condition of 40°C ± 2°C and 90 to 95%RH, allow the parts to stabilize in normal temperature and humidity for 24 ± 2 hours, before measurement. The charge and discharge current of the capacitor must not exceed 50mA for IR measurement.	No problem observed									
	ΔC		Within ± 7.5% or ± 0.75pF, whichever is larger									
	Q		C ≥ 30pF : Q ≥ 200 C < 30pF : Q ≥ 100 + 10C / 3									
	IR		Over 500MΩ or 25MΩ·μF, whichever is less									
High-Temperature Load	Appearance	After applying *twice the rated voltage in the temperature of 125 ± 3°C for 1000 + 12 / - 0 hours, measure the sample after 24 ± 2 hours in normal temperature and humidity. The charge and discharge current of the capacitor must not exceed 50mA for IR measurement. *Applied voltages for respective products are indicated in the chart below.	No problem observed.									
	ΔC		Within ± 3% or ± 0.3pF, whichever is larger									
	Q		C ≥ 30pF : Q ≥ 350 10pF < C < 30pF : Q ≥ 275 + 5C / 2 C < 10pF : Q ≥ 200 + 10C									
	IR		Over 1000MΩ or 50MΩ·μF, whichever is less									

Please ask for individual specification for the hatched range in previous chart.

Voltage to be applied in the High Temperature Load (Applied voltage is the multiple of the rated voltage)

Applied Voltage	Rated Voltage	Products
× 1.0	16V	CM02CA221
× 1.2	25V	CM02CAR20-120



Test Conditions and Standards

Substrate for Adhesion Strength Test, Vibration Test, Soldering Heat Resistance Test, Temperature Cycle Test, Load Humidity Test, High-Temperature with Loading Test.

(Unit: mm)

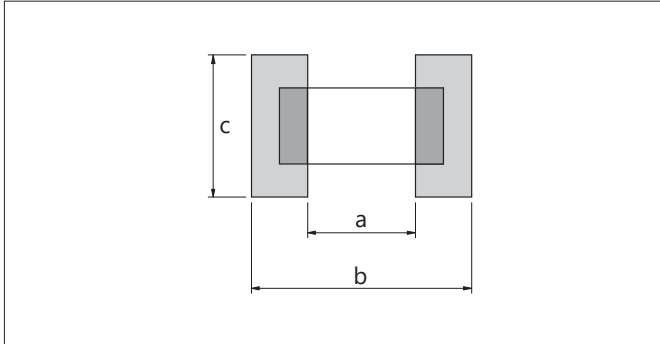

Size (EIA Code)	a	b	c
02 (01005)	0.15	0.5	0.2
03 (0201)	0.26	0.92	0.32
05 (0402)	0.4	1.4	0.5
105 (0603)	1.0	3.0	1.2
21 (0805)	1.2	4.0	1.65
316 (1206)	2.2	5.0	2.0
32 (1210)	2.2	5.0	2.9

Substrate for Bending Test

(Unit: mm)

Testing Board : Glass Epoxy Board (GE4 or FR4)
 Testing Board Thickness : 1.6±0.2mm*
 Circuit Thickness : 0.04±0.01mm

*02, 03, 05 size 0.8±0.1mm

Structure

Plated Termination

Internal Electrodes (Ni or Cu)

Dielectric Ceramic Layer
 Temperature compensation: Zirconate family
 High dielectric constant: Barium Titanate family

External Termination Electrodes (Cu or CuNi)

Ni Plating

Sn Plating

About official Standards Certification

- The sites that manufacture the products listed in this catalog have acquired ISO 9001 quality management system (certification).
- The production site is Kagoshima Kokubu Plant.



Packaging Options Tape and Reel

Reel

(Unit: mm)

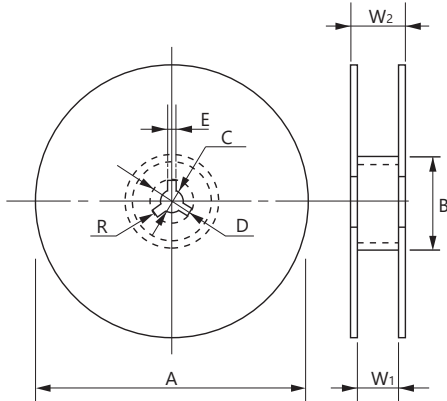

Code Reel	A	B	C	D
7-inch Reel (CODE: T, H, Q)	180 ⁺⁰ / _{-2.0}	φ60 min.	13±0.5	21±0.8
7-inch Reel (CODE: P)	178±2.0			
13-inch Reel (CODE: L, N, W)	330±2.0			
Code Reel	E	W ₁	W ₂	R
7-inch Reel (CODE: T, H, Q)	2.0±0.5	10.5±1.5	16.5 max.	1.0
7-inch Reel (CODE: P)		4.35±0.3	6.95±1.0	
13-inch Reel (CODE: L, N, W)		9.5±1.0	16.5 max.	

Carrier Tape

(Unit: mm)

F=1mm (02 Size)

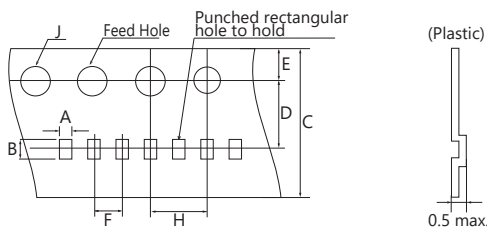

F=2mm (02, 03, 05 Size)

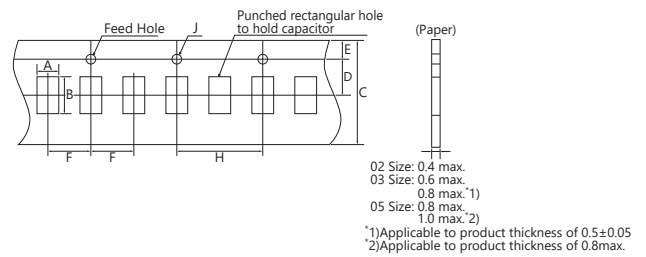

F=1mm (03, 05 Size)

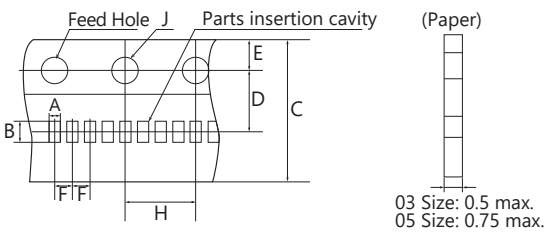

F=4mm (105, 21, 316, 32 Size)

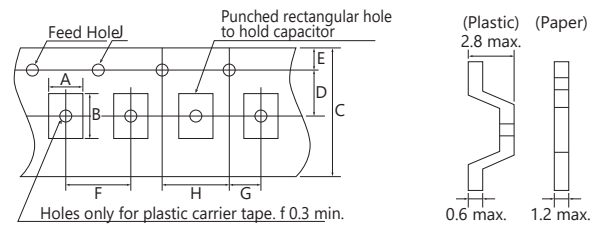

(Unit: mm)

Size (EIA Code)	A	B	C	D	E	F	G	H	J	Carrier Tape	
										Width	Material
02 (01005)*	0.24±0.02	0.44±0.02	4.0±0.08	1.8±0.02	0.9±0.05	1.0±0.02	—	2.0±0.04	0.8±0.04	4mm	Plastic
	0.25±0.03	0.45±0.03	8.0±0.3	3.5±0.05	1.75±0.1	2.0±0.05	—	4.0±0.1	1.5±0.1/-0	8mm	Paper
03 (0201)*	0.37±0.03	0.67±0.03	8.0+0.3/-0.1	3.5±0.05	1.75±0.1	1.0±0.05	—	4.0±0.05	1.5±0.1/-0	8mm	Paper
			8.0±0.3			2.0±0.05		4.0±0.1			
	0.39±0.03	0.69±0.03	8.0±0.3	3.5±0.05	1.75±0.1	2.0±0.05	—	4.0±0.1	1.5±0.1/-0		
	0.42±0.03	0.72±0.03	8.0±0.3	3.5±0.05	1.75±0.1	2.0±0.05	—	4.0±0.1	1.5±0.1/-0		
05 (0402)*	0.65±0.1	1.15±0.1	8.0+0.3/-0.1	3.5±0.05	1.75±0.1	1.0±0.05	—	4.0±0.05	1.5±0.1/-0	8mm	Paper
			8.0±0.3			2.0±0.05		4.0±0.1			
	0.8±0.1	1.3±0.1	8.0±0.3	3.5±0.05	1.75±0.1	2.0±0.05	—	4.0±0.1	1.5±0.1/-0		
105 (0603)*	1.0±0.2	1.8±0.2	8.0±0.3	3.5±0.05	1.75±0.1	4.0±0.1	2.0±0.05	4.0±0.1	1.5±0.1/-0	8mm	Paper
	1.1±0.2	1.9±0.2	8.0±0.3	3.5±0.05	1.75±0.1	4.0±0.1	2.0±0.05	4.0±0.1	1.5±0.1/-0		
21 (0805)	1.5±0.2	2.3±0.2	8.0±0.3	3.5±0.05	1.75±0.1	4.0±0.1	2.0±0.05	4.0±0.1	1.5±0.1/-0	8mm	Paper
										8mm	Plastic
316 (1206)	2.0±0.2	3.6±0.2	8.0±0.3	3.5±0.05	1.75±0.1	4.0±0.1	2.0±0.05	4.0±0.1	1.5±0.1/-0	8mm	Paper
										8mm	Plastic
32 (1210)	2.9±0.2	3.6±0.2	8.0±0.3	3.5±0.05	1.75±0.1	4.0±0.1	2.0±0.05	4.0±0.1	1.5±0.1/-0	8mm	Plastic

* Option



Packaging Options

Detail of leader and trailer

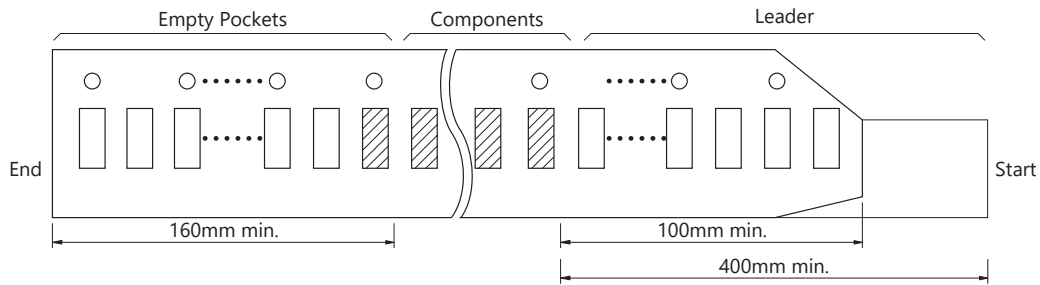

Adhesive tape

- 1) The exfoliative strength when peeling off the top tape from the carrier tape by the method of the following figure shall be *0.1 to 0.7N. *02 Size: 0.1 to 0.5N
- 2) When the top tape is peeled off, the adhesive stays on the top tape.
- 3) Chip capacitors will be in a state free without being stuck on the thermal adhesive tape.

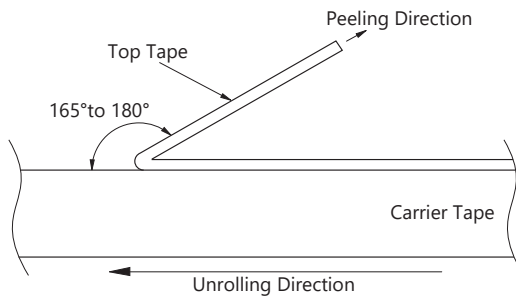

Exfoliating angle: 165 to 180 degrees to the carrier tape.
Exfoliating speed: 300 mm/min.

Carrier tape

- 1) Chip will not fall off from carrier tape or carrier tape will not be damaged by bending than within a radius of 25mm.
- 2) The chip are inserted continuously without any empty pocket.
- 3) Chip will not be mis-mounted because of too big clearance between components and cavity. Also the waste of carrier tape will not fill a nozzle hole of mounting machine.



Surface Mounting Information

Dimensions for recommended typical land

Since the amount of solder (size of fillet) to be used has direct influence on the capacitor after mounting, the sufficient consideration is necessary.

When the amounts of solder is too much, the stress that a capacitor receives becomes larger. It may become the cause of a crack in the capacitor. When the land design of printed wiring board is considered, it is necessary to set up the form and size of land pattern so that the amount of solder is suitable.

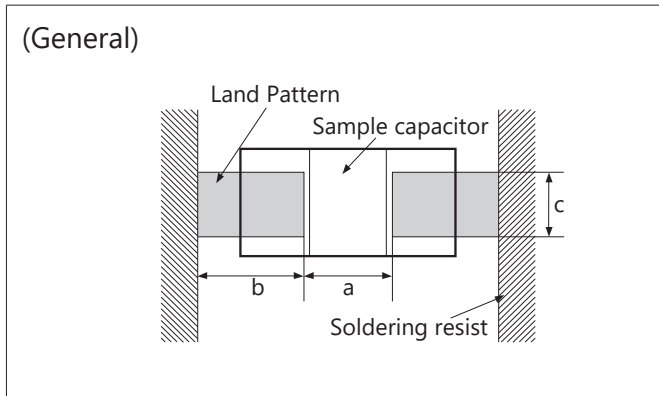

General

(Unit: mm)

Size (EIA Code)	Dimension		Recommended land dimensions		
	L	W	a	b	c
02 (01005)	0.4±0.02	0.2±0.02	0.13 to 0.2	0.12 to 0.18	0.2 to 0.23
	0.6±0.03	0.3±0.03	0.2 to 0.25	0.25 to 0.35	0.3 to 0.4
03 (0201)	0.6±0.05	0.3±0.05			
	05 (0402)	0.6±0.09	0.3±0.09	0.23 to 0.3	0.25 to 0.35
105 (0603)		1.0±0.05	0.5±0.05	0.3 to 0.5	0.35 to 0.45
	1.0±0.15	0.5±0.15	0.4 to 0.6	0.4 to 0.5	0.5 to 0.75
	1.0±0.2	0.5±0.2			
21 (0805)	1.6±0.1	0.8±0.1	0.7 to 1.0	0.8 to 1.0	0.6 to 0.9
	1.6±0.15	0.8±0.15	0.8 to 1.0	0.8 to 1.0	0.8 to 1.1
	1.6±0.2	0.8±0.2			
	1.6±0.25	0.8±0.25			
316 (1206)	2.0±0.1	1.25±0.1	1.0 to 1.3	1.0 to 1.2	1.0 to 1.45
	2.0±0.15	1.25±0.15	1.0 to 1.3	1.0 to 1.2	1.25 to 1.55
	2.0±0.2	1.25±0.2			
32 (1210)	3.2±0.2	1.6±0.15	2.1 to 2.5	1.1 to 1.3	1.4 to 1.9
	3.2±0.2	1.6±0.2	2.1 to 2.5	1.1 to 1.3	1.6 to 2.0
	3.2±0.3	1.6±0.3			
32 (1210)	3.2±0.3	2.5±0.2	2.1 to 2.5	1.1 to 1.3	1.9 to 2.8

* Recommended land dimensions may differ depending on dimensional tolerance.

Design of printed circuit and Soldering

The recommended fillet height shall be 1/2 of the thickness of capacitors or 0.5mm. When mounting two or more capacitors in the common land, it is necessary to separate the land with the solder resist strike so that it may become the exclusive land of each capacitor.

Ideal Solder Height

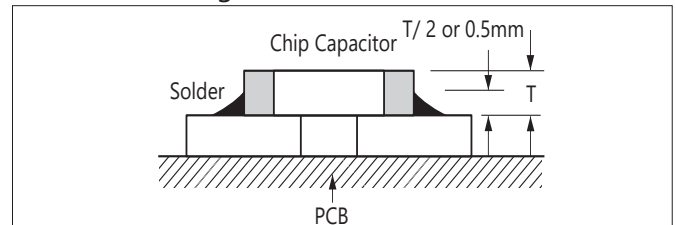

Item	Prohibited	Recommended example : Separation by solder resist
Multiple parts mount		
Mount with leaded parts		
Wire soldering after mounting		
Side by side layout		



Surface Mounting Information

Mounting Design

The chip could crack if the PCB warps during processing after the chip has been soldered.

Recommended chip position on PCB to minimize stress from PCB warpage

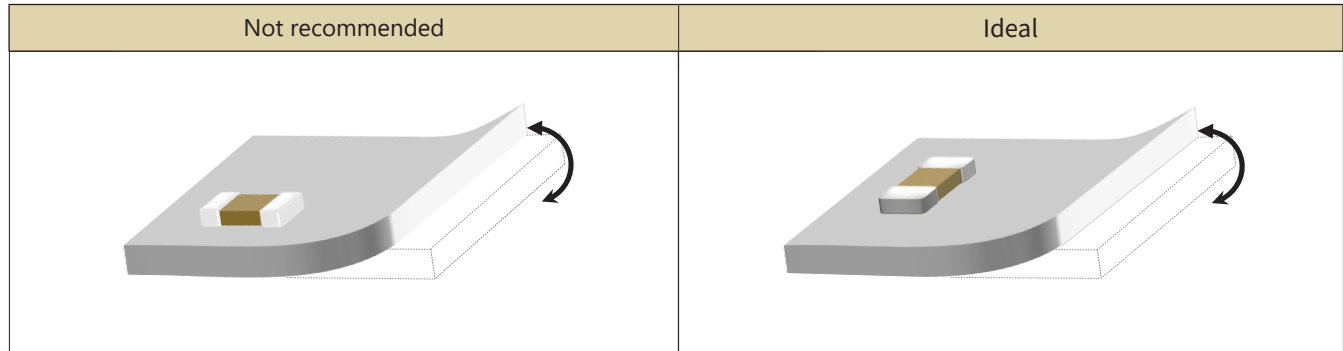

Actual Mounting

- 1) If the position of the vacuum nozzle is too low, a large force may be applied to the chip capacitor during mounting, resulting in cracking.
- 2) During mounting, set the nozzle pressure to a static load of 1 to 3 N.
- 3) To minimize the shock of the vacuum nozzle, provide a support pin on the back of the PCB to minimize PCB flexure.

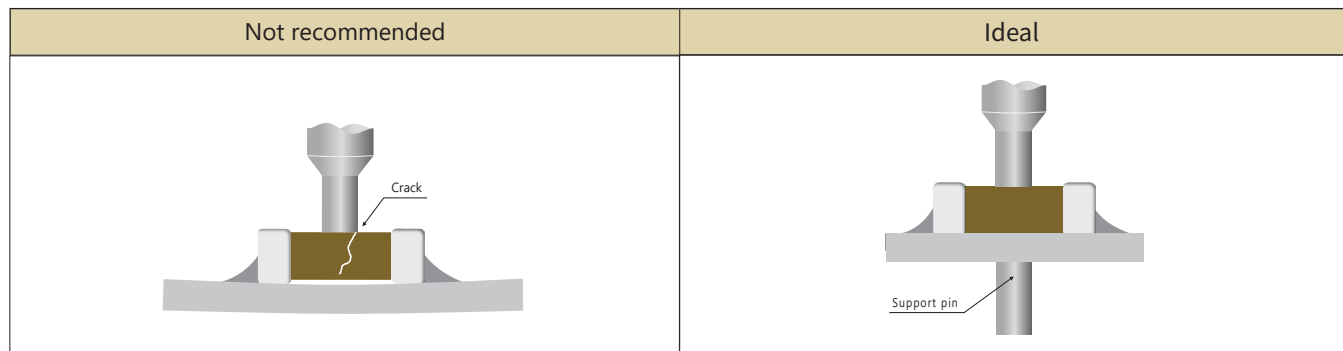

- 4) Bottom position of pick up nozzle should be adjusted to the top surface of a substrate which camber is corrected.

Resin Mold

- 1) If a large amount of resin is used for molding the chip, cracks may occur due to contraction stress during curing. To avoid such cracks, use a low shrinkage resin.
- 2) The insulation resistance of the chip will degrade due to moisture absorption. Use a low moisture absorption resin.
- 3) Check carefully that the resin does not generate a decomposition gas or reaction gas during the curing process or during normal storage. Such gases may crack the chip capacitor or damage the device itself.



Surface Mounting Information

Soldering Method

- 1) Ceramic is easily damaged by rapid heating or cooling. If some heat shock is unavoidable, preheat enough to limit the temperature difference (Delta T) to within 150 degree Celsius.
- 2) The product size 1.6×0.8mm to 3.2×1.6mm can be used in reflow and wave soldering, and the product size of bigger than 3.2×1.6mm, or smaller than 1.6×0.8mm can be used in reflow.
Circuit shortage and smoking can be created by using capacitors which are used neglecting the above caution.
- 3) Please see our recommended soldering conditions.
- 4) In case of using Sn-Zn Solder, please contact us in advance.
- 5) The following condition is recommended for spot heater application.

Recommended spot heater condition

Item	Condition
Distance	5mm min.
Angle	45°
Projection Temp.	400°C max.
Flow rate	Set at the minimum
Nozzle diameter	2φ to 4φ (Single hole type)
Application time	10 sec. max. (1206 and smaller) 30 sec. max. (1210 and larger)

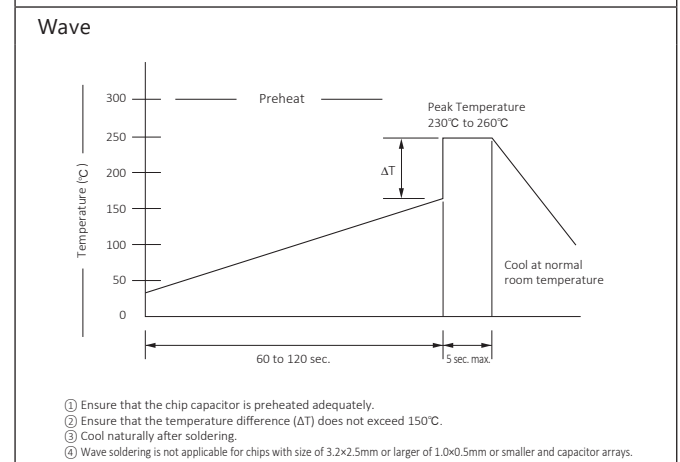
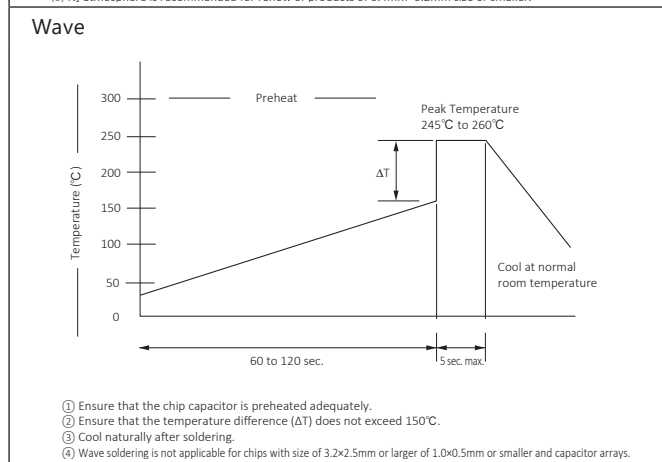
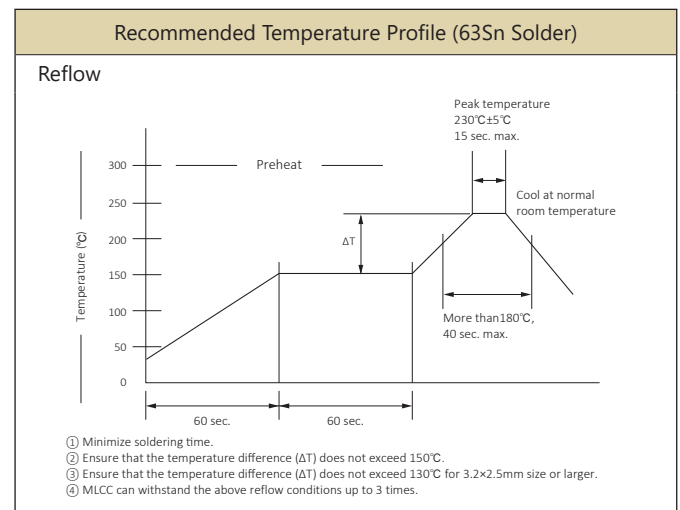
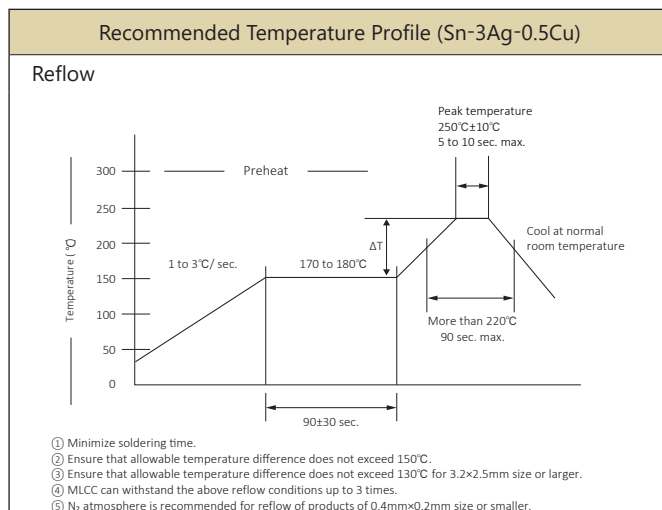
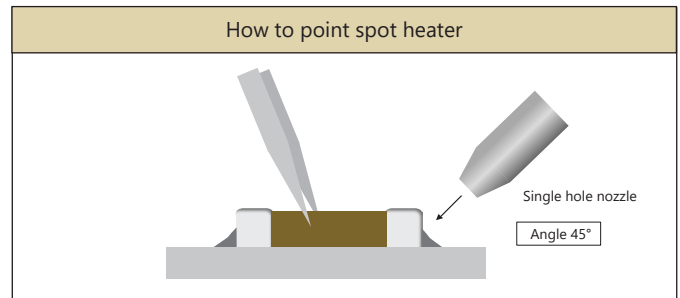



Precautions

Circuit Design

1. Once application and assembly environments have been checked, the capacitor may be used in conformance with the rating and performance which are provided in both the catalog and the specifications. Use exceeding that which is specified may result in inferior performance or cause a short, open, smoking, or flaming to occur, etc.
2. Please consult the manufacturer in advance when the capacitor is used in devices such as: devices which deal with human life, i.e. medical devices; devices which are highly public orientated; and devices which demand a high standard of liability.
Accident or malfunction of devices such as medical devices, space equipment and devices having to do with atomic power could generate grave consequence with respect to human lives or, possibly, a portion of the public. Capacitors used in these devices may require high reliability design different from that of general purpose capacitors.
3. Please use the capacitors in conformance with the operating temperature provided in both the catalog and the specifications.
Be especially cautious not to exceed the maximum temperature. In the situation the maximum temperature set forth in both the catalog and specifications is exceeded, the capacitor's insulation resistance may deteriorate, power may suddenly surge and short-circuit may occur.
The capacitor has a loss, and may self-heat due to equivalent series resistance when alternating electric current is passed therethrough. As this effect becomes especially pronounced in high frequency circuits, please exercise caution.
When using the capacitor in a (self-heating) circuit, please make sure the surface of the capacitor remains under the maximum temperature for usage. Also, please make certain temperature rises remain below 20°C.
4. Please keep voltage under the rated voltage which is applied to the capacitor. Also, please make certain the peak voltage remains below the rated voltage when AC voltage is super-imposed to the DC voltage.
In the situation where AC or pulse voltage is employed, ensure average peak voltage does not exceed the rated voltage.
Exceeding the rated voltage provided in both catalog and specifications may lead to defective withstanding voltage or, in worst case situations, may cause the capacitor to smoke or flame.
5. When the capacitor is to be employed in a circuit in which there is continuous application of a high frequency voltage or a steep pulse voltage, even though it is within the rated voltage, please inquire to the manufacturer.
In the situation the capacitor is to be employed using a high frequency AC voltage or a extremely fast rising pulse voltage, even though it is within the rated voltage, it is possible capacitor reliability will deteriorate.
6. It is a common phenomenon of high-dielectric products to have a deteriorated amount of static electricity due to the application of DC voltage.
Due caution is necessary as the degree of deterioration varies depending on the quality of capacitor materials, capacity, as well as the load voltage at the time of operation.
7. Do not use the capacitor in an environment where it might easily exceed the respective provisions concerning shock and vibration specified in the catalog and specifications.
In addition, it is a common piezo phenomenon of high dielectric products to have some voltage due to vibration or to have noise due to voltage change. Please contact sales in such case.
8. If the electrostatic capacity value of the delivered capacitor is within the specified tolerance, please consider this when designing the respective product in order that the assembled product function appropriately.
9. Please contact us upon using conductive adhesives.

Storage

Please note the following regarding the storage of delivered products.

1. Set the storage temperature to + 5 to + 40 °C and humidity to 20 ~ 70% RH. Other meteorological conditions are in accordance with classification 1 K2 of JIS C 60721 -3 -1.
2. Store in a place where corrosive gas (H₂S, SO₂, NO₂, Cl₂, etc.) does not exist in the atmosphere. Also, avoid exposure to salty moisture. In either case, this may cause oxidation corrosion of the terminal electrode, reducing solderability.

If you store the above delivered products according to the conditions listed above, it will satisfy the solderability standard for 6 months from the shipping date.

Safety application guideline and detailed information of electrical properties are also provided in kyocera web site;
URL: <https://ele.kyocera.com/en/product/capacitor/>



Part Number List



High-Q CU02 Series Size (JIS Code) : 01005(0402) # Packaging Code (Packaging quantity) : H(20,000pcs.) / N(80,000pcs.) / P(40,000pcs.)

Dielectric code CA	Capacitance	□:Tolerance	Voltage [V]	Part Number	Q	Dimension			# Packaging Code (quantity)
						L[mm]	W[mm]	T[mm]	
CG/CH	0.2pF	B:±0.1pF / C:±0.25pF	25	CU02CA20□25A#	404	0.4±0.02	0.2±0.02	0.2±0.02	H / N / P
			16	CU02CA20□16A#	404	0.4±0.02	0.2±0.02	0.2±0.02	H / N / P
	25	CU02CA50□25A#	410	0.4±0.02	0.2±0.02	0.2±0.02	H / N / P		
	0.5pF	B:±0.1pF / C:±0.25pF	16	CU02CA50□16A#	410	0.4±0.02	0.2±0.02	0.2±0.02	H / N / P
			25	CU02CA1R0□25A#	420	0.4±0.02	0.2±0.02	0.2±0.02	H / N / P
	1pF	B:±0.1pF / C:±0.25pF	16	CU02CA1R0□16A#	420	0.4±0.02	0.2±0.02	0.2±0.02	H / N / P
			25	CU02CA1R5□25A#	430	0.4±0.02	0.2±0.02	0.2±0.02	H / N / P
	1.5pF	B:±0.1pF / C:±0.25pF	16	CU02CA1R5□16A#	430	0.4±0.02	0.2±0.02	0.2±0.02	H / N / P
			25	CU02CA2R0□25A#	440	0.4±0.02	0.2±0.02	0.2±0.02	H / N / P
	2pF	B:±0.1pF / C:±0.25pF	16	CU02CA2R0□16A#	440	0.4±0.02	0.2±0.02	0.2±0.02	H / N / P
			25	CU02CA3R0□25A#	460	0.4±0.02	0.2±0.02	0.2±0.02	H / N / P
	3pF	B:±0.1pF / C:±0.25pF	16	CU02CA3R0□16A#	460	0.4±0.02	0.2±0.02	0.2±0.02	H / N / P
			25	CU02CA4R0□25A#	480	0.4±0.02	0.2±0.02	0.2±0.02	H / N / P
	4pF	B:±0.1pF / C:±0.25pF	16	CU02CA4R0□16A#	480	0.4±0.02	0.2±0.02	0.2±0.02	H / N / P
			25	CU02CA5R0□25A#	500	0.4±0.02	0.2±0.02	0.2±0.02	H / N / P
	5pF	B:±0.1pF / C:±0.25pF	16	CU02CA5R0□16A#	500	0.4±0.02	0.2±0.02	0.2±0.02	H / N / P
			25	CU02CA6R0□25A#	520	0.4±0.02	0.2±0.02	0.2±0.02	H / N / P
	6pF	C:±0.25pF / D:±0.5pF	16	CU02CA6R0□16A#	520	0.4±0.02	0.2±0.02	0.2±0.02	H / N / P
			25	CU02CA7R0□25A#	540	0.4±0.02	0.2±0.02	0.2±0.02	H / N / P
	7pF	C:±0.25pF / D:±0.5pF	16	CU02CA7R0□16A#	540	0.4±0.02	0.2±0.02	0.2±0.02	H / N / P
			25	CU02CA8R0□25A#	560	0.4±0.02	0.2±0.02	0.2±0.02	H / N / P
	8pF	C:±0.25pF / D:±0.5pF	16	CU02CA8R0□16A#	560	0.4±0.02	0.2±0.02	0.2±0.02	H / N / P
			25	CU02CA9R0□25A#	580	0.4±0.02	0.2±0.02	0.2±0.02	H / N / P
	9pF	C:±0.25pF / D:±0.5pF	16	CU02CA9R0□16A#	580	0.4±0.02	0.2±0.02	0.2±0.02	H / N / P
			25	CU02CA100□25A#	600	0.4±0.02	0.2±0.02	0.2±0.02	H / N / P
	10pF	J:±5% / K:±10%	16	CU02CA100□16A#	600	0.4±0.02	0.2±0.02	0.2±0.02	H / N / P
			25	CU02CA120□25A#	640	0.4±0.02	0.2±0.02	0.2±0.02	H / N / P
	12pF	J:±5% / K:±10%	16	CU02CA120□16A#	640	0.4±0.02	0.2±0.02	0.2±0.02	H / N / P
			25	CU02CA150□25A#	700	0.4±0.02	0.2±0.02	0.2±0.02	H / N / P
	15pF	J:±5% / K:±10%	16	CU02CA150□16A#	700	0.4±0.02	0.2±0.02	0.2±0.02	H / N / P
18pF	CU02CA180□25A#			760	0.4±0.02	0.2±0.02	0.2±0.02	H / N / P	
22pF	CU02CA220□16A#			840	0.4±0.02	0.2±0.02	0.2±0.02	H / N / P	
24pF	CU02CA240□16A#			880	0.4±0.02	0.2±0.02	0.2±0.02	H / N / P	



1. Specifications described in this catalog are for references. Products specifications shall be based on written documents agreed by each party.
2. Contents in this catalog are subject to change without notice. It is recommended to confirm the latest information at the time of usage. Also, Kyocera Electronic Components Catalog is revised once a year. We may not be able to accept requests based on old catalogs.
3. Products in this catalog are intended to be used in general electronic equipment such as office equipment, audio and visual equipment, communication equipment, measurement instrument and home appliances. It is absolutely recommended to consult with our sales representatives in advance upon planning to use our products in applications which require extremely high quality and reliability such as aircraft and aerospace equipment, traffic systems, safety systems, power plant and medical equipment including life maintenance systems.
4. Even though we strive for improvements of quality and reliability of products, it is requested to design with enough safety margin in equipment or systems in order not to threaten human lives directly or damage human bodies or properties by an accidental result of products.
5. It is requested to design based on guaranteed specifications for such as maximum ratings, operating voltage and operating temperature. It is not the scope of our guarantee for unsatisfactory results due to misuse or inadequate usage of products in the catalog.
6. Operation summaries and circuit examples in this catalog are intended to explain typical operation and usage of the product. It is recommended to perform circuit and assembly design considering surrounding conditions upon using products in this catalog.
7. Technical information described in this catalog is meant to explain typical operations and applications of products, and it is not intended to guarantee or license intellectual properties or other industrial rights of the third party or Kyocera.
8. Trademarks, logos and brand names used in this catalog are owned by Kyocera or the corresponding third party.
9. Certain products in this catalog are subject to the Foreign Exchange and Foreign Trade Control Act of Japan, and require the license from Japanese Government upon exporting the restricted products and technical information under the law.
Besides, it is requested not to use products and technical information in the catalog for the development and/or manufacture of weapons of mass destruction or other conventional weapons, nor to provide them to any third party with the possibility of having such purposes.
10. It is prohibited to reprint and reproduce a part or whole of this catalog without permission.
11. Contents described herein are as of February 2022.