



# Thyristor Module

## K05TA150P080AAA

### 特徴

#### Feature

- RoHS 指令準拠  
RoHS Compliant

### 用途

#### Application

- 一般整流用  
For General Use



### 外形図

#### Outline Drawing

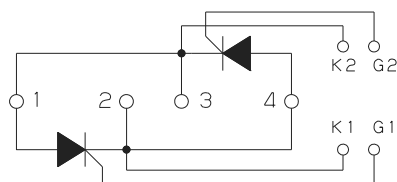
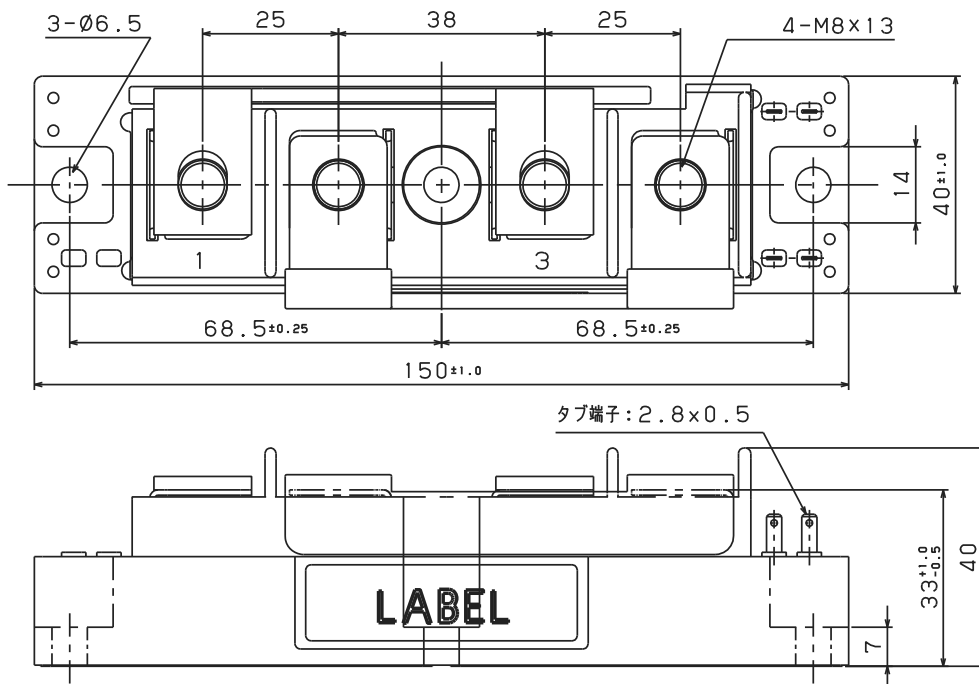

回路構成 Circuit Schema

【単位：mm】

最大定格 Maximum Ratings

項目 Parameter	記号 Symbol	耐圧クラス Grade		単位 Unit
		K05TA150P080AAA		
くり返しピークオフ電圧 Repetitive Peak Off-State Voltage	V <sub>DRM</sub>	800		V
非くり返しピークオフ電圧 Non Repetitive Peak Off-State Voltage	V <sub>DSM</sub>	900		V
くり返しピーク逆電圧 Repetitive Peak Reverse Voltage	V <sub>RRM</sub>	800		V
非くり返しピーク逆電圧 Non Repetitive Peak Reverse Voltage	V <sub>RSM</sub>	900		V

項目 Parameter	記号 Symbol	条件 Conditions	定格値 Max. Rated Value	単位 Unit		
平均整流電流 Average Rectified Output Current	I <sub>T(AV)</sub>	商用周波数 180° 通電 Tc=84°C Half Sine Wave	150	A		
実効オン電流 RMS On-State Current	I <sub>T</sub> (RMS)		235	A		
サージオン電流 Surge On-State Current	I <sub>TSM</sub>	50Hz 正弦半波, 1 サイクル, 非くり返し Half Sine Wave, 1Pulse, Non-Repetitive	3200	A		
電流二乗時間積 I Squared t	I <sup>2</sup> t	2~10ms	51200	A <sup>2</sup> s		
臨界オン電流上昇率 Critical Rate of Rise of Turned-On Current	di/dt	V <sub>D</sub> = 2/3V <sub>DRM</sub> I <sub>TM</sub> = 2I <sub>T</sub> , T <sub>j</sub> = 125°C I <sub>G</sub> = 300mA, di <sub>G</sub> /dt= 0.2A/μs	100	A/μs		
ピークゲート電力損失 Peak Gate Power	P <sub>GM</sub>		5	W		
平均ゲート電力損失 Average Gate Power	P <sub>G(AV)</sub>		1	W		
ピークゲート電流 Peak Gate Current	I <sub>GM</sub>		2	A		
ピークゲート電圧 Peak Gate Voltage	V <sub>GM</sub>		10	V		
ピークゲート逆電圧 Peak Gate Reverse Voltage	V <sub>RGM</sub>		5	V		
動作接合温度範囲 Operating Junction Temperature Range	T <sub>jw</sub>		-40 ~ +125	°C		
保存温度範囲 Storage Temperature Range	T <sub>stg</sub>		-40 ~ +125	°C		
絶縁耐圧 Isolation Voltage	V <sub>iso</sub>	端子-ベース間, AC 1 分間 Terminal to Base, AC 1min.	2500	V		
締付トルク Mounting Torque	ベース部 Base	F	サーマルコンパウンド塗布 Greased	M6	2.5 ~ 3.5	N・m
	主端子部 Terminal			M8	9.0 ~ 10.0	N・m

1 アーム当りの値 Value Per 1 Arm.

電氣的特性 Electrical Characteristics

項目 Parameter	記号 Symbol	条件 Conditions		特性値 Values			単位 Unit
				最小 Min.	標準 Typ.	最大 Max.	
ピークオフ電流 Peak Off-State Current	$I_{DM}$	$T_j = 125^\circ\text{C}$ , $V_{DM} = V_{DRM}$				15	mA
ピーク逆電流 Peak Reverse Current	$I_{RM}$	$T_j = 125^\circ\text{C}$ , $V_{RM} = V_{RRM}$				15	mA
ピークオン電圧 Peak On-State Voltage	$V_{TM}$	$T_j = 25^\circ\text{C}$ $I_{TM} = 450\text{A}$	Terminal			1.36	V
			Chip			1.25	
	$V_{(TO)}^{*1}$	$T_j = 125^\circ\text{C}$				0.80	V
	$r_t^{*1}$	$T_j = 125^\circ\text{C}$				0.88	m $\Omega$
トリガゲート電流 Gate Current to Trigger	$I_{GT}$	$V_D = 6\text{V}$ , $I_T = 1\text{A}$	$T_j = -40^\circ\text{C}$			300	mA
			$T_j = 25^\circ\text{C}$			150	mA
			$T_j = 125^\circ\text{C}$			80	mA
トリガゲート電圧 Gate Voltage to Trigger	$V_{GT}$	$V_D = 6\text{V}$ , $I_T = 1\text{A}$	$T_j = -40^\circ\text{C}$			5	V
			$T_j = 25^\circ\text{C}$			3	V
			$T_j = 125^\circ\text{C}$			2	V
非トリガゲート電圧 Gate Non-Trigger Voltage	$V_{GD}$	$T_j = 125^\circ\text{C}$ , $V_D = 2/3V_{DRM}$		0.25			V
臨界オフ電圧上昇率 Critical Rate of Rise of Off-State Voltage	$dv/dt$	$T_j = 125^\circ\text{C}$ , $V_D = 2/3V_{DRM}$ , $R_{GK} = 33\Omega$		500			V/ $\mu\text{s}$
ターンオフ時間 Turn-Off Time	$t_q$	$T_j = 125^\circ\text{C}$ , $I_{TM} = I_T$ , $V_D = 2/3V_{DRM}$ $dv/dt = 20\text{V}/\mu\text{s}$ , $V_R = 100\text{V}$ , $-di/dt = 20\text{A}/\mu\text{s}$			100		$\mu\text{s}$
ターンオン時間 Turn-On Time	$t_{gt}$				6		$\mu\text{s}$
遅れ時間 Delay Time	$t_d$	$T_j = 25^\circ\text{C}$ , $V_D = 2/3V_{DRM}$ $I_G = 300\text{mA}$ , $di_G/dt = 0.2\text{A}/\mu\text{s}$			2		$\mu\text{s}$
立上がり時間 Rise Time	$t_r$				4		$\mu\text{s}$
ラッチング電流 Latching Current	$I_L$	$T_j = 25^\circ\text{C}$			100		mA
保持電流 Holding Current	$I_H$	$T_j = 25^\circ\text{C}$			60		mA
熱抵抗 Thermal Resistance	$R_{th(j-c)}$	接合部-ケース間( $T_c$ 測定点:チップ直下) Junction to Case				0.2	$^\circ\text{C}/\text{W}$
接触熱抵抗 Thermal Resistance	$R_{th(c-f)}$	ケース-フィン間, サーマルコンパウンド塗布 Case to Fin, Greased				0.1	$^\circ\text{C}/\text{W}$

質量 --- 約 450g Approximate Weight

1 アーム当りの値 Value Per 1 Arm.

\*1 :  $V_T = V_{(TO)} + I_T \times r_t$  For power-loss calculation only

オン電圧特性  
ON-STATE CURRENT VS. VOLTAGE

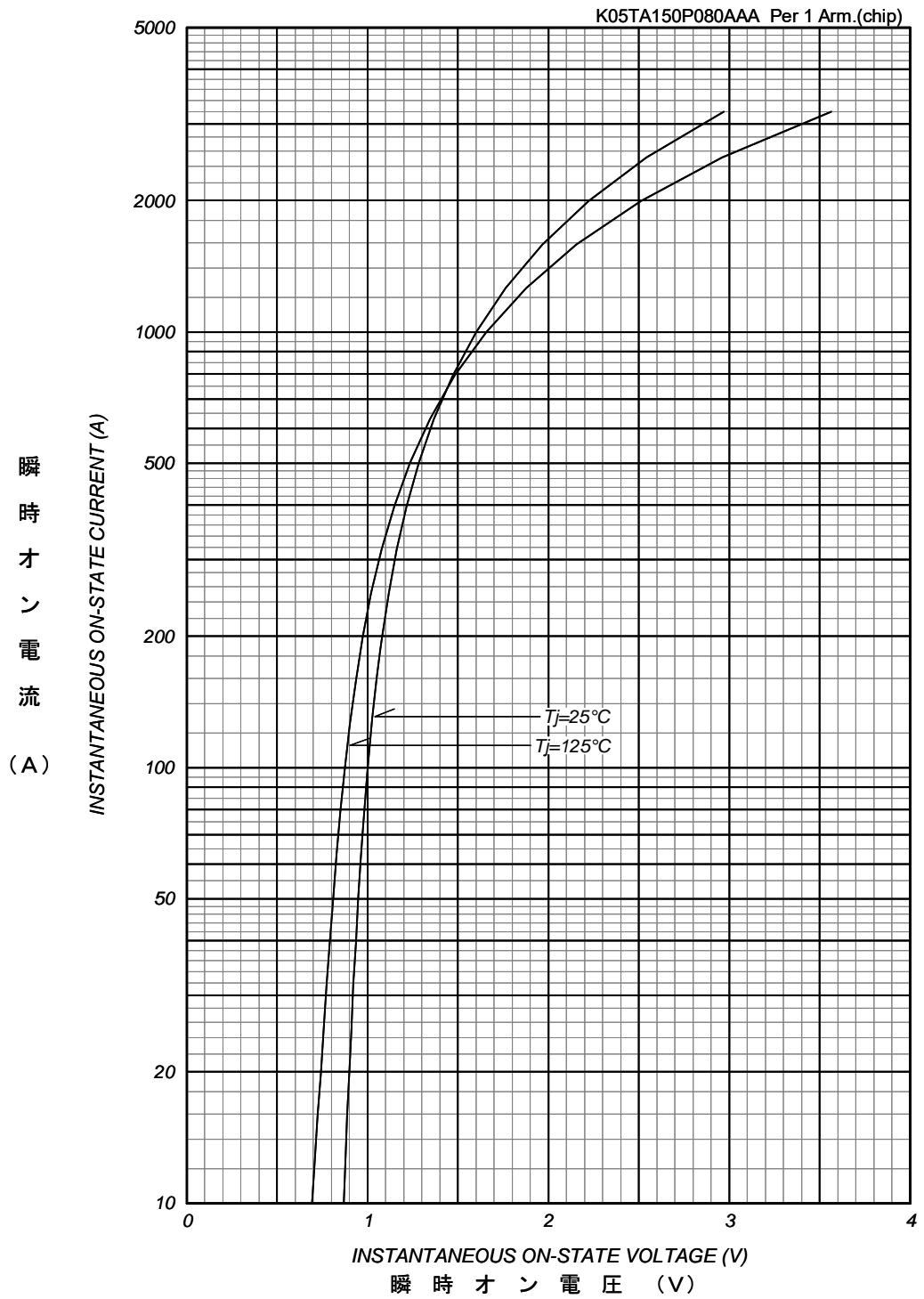

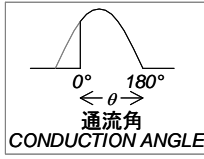

平均オン電力損失特性  
AVERAGE ON-STATE POWER DISSIPATION

for SINUSOIDAL CURRENT WAVEFORM

K05TA150P080AAA Per 1 Arm.(chip)

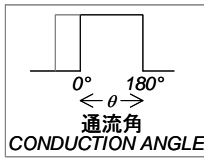
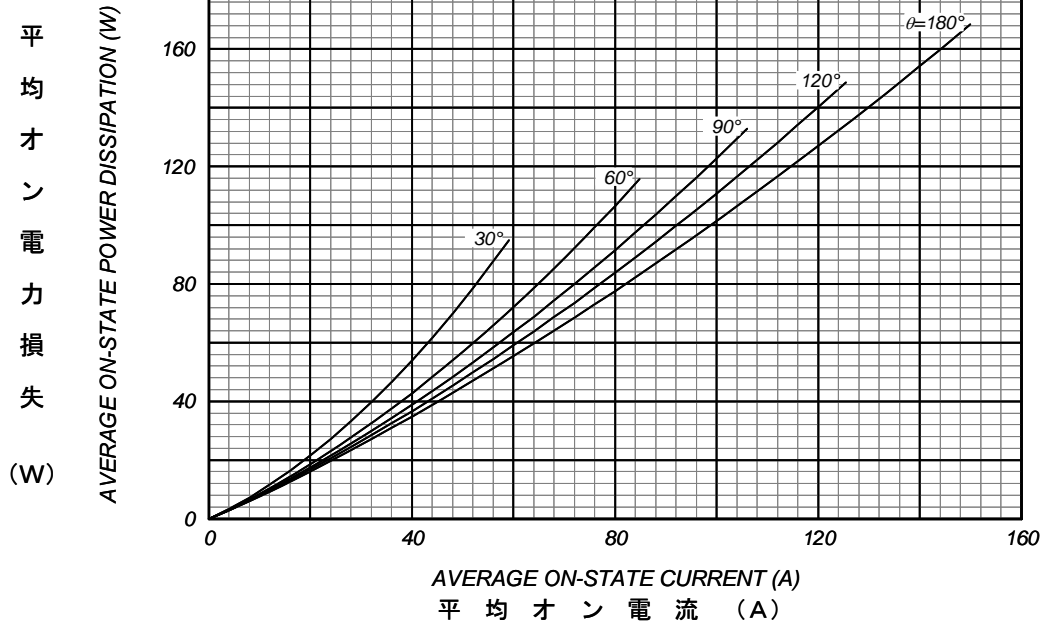

平均オン電力損失特性  
AVERAGE ON-STATE POWER DISSIPATION

for RECTANGULAR CURRENT WAVEFORM

K05TA150P080AAA Per 1 Arm.(chip)

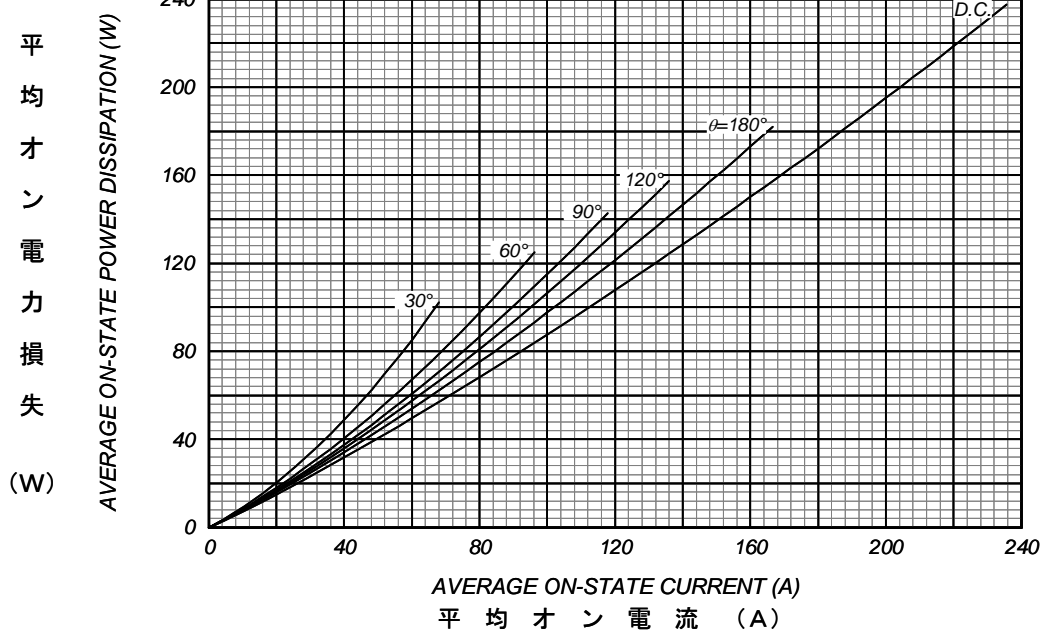

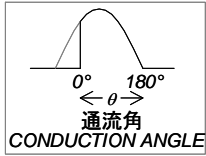

平均オン電流 - ケース温度定格  
AVERAGE ON-STATE CURRENT VS. CASE TEMPERATURE

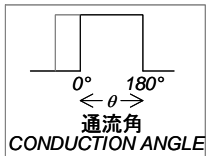
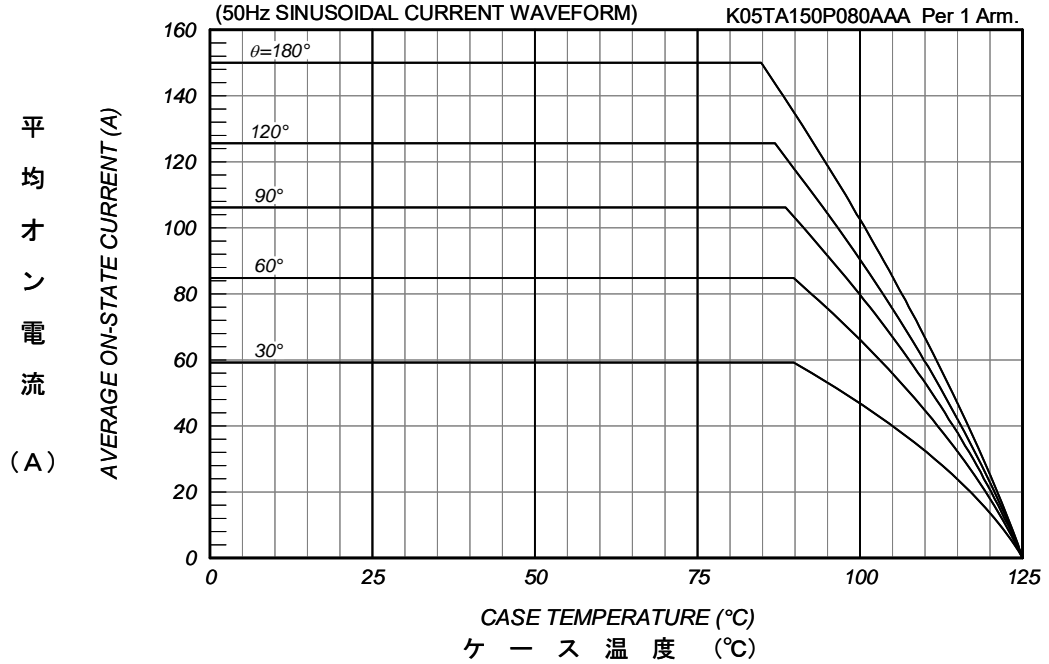

平均オン電流 - ケース温度定格  
AVERAGE ON-STATE CURRENT VS. CASE TEMPERATURE

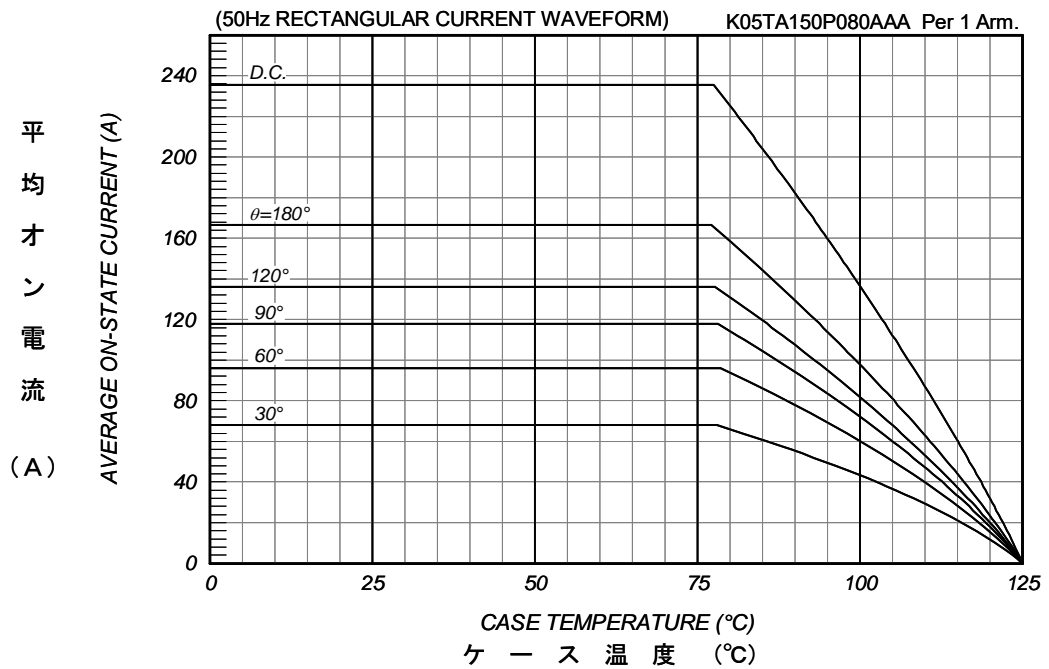

ゲート特性  
GATE CHARACTERISTICS

K05TA150P080AAA

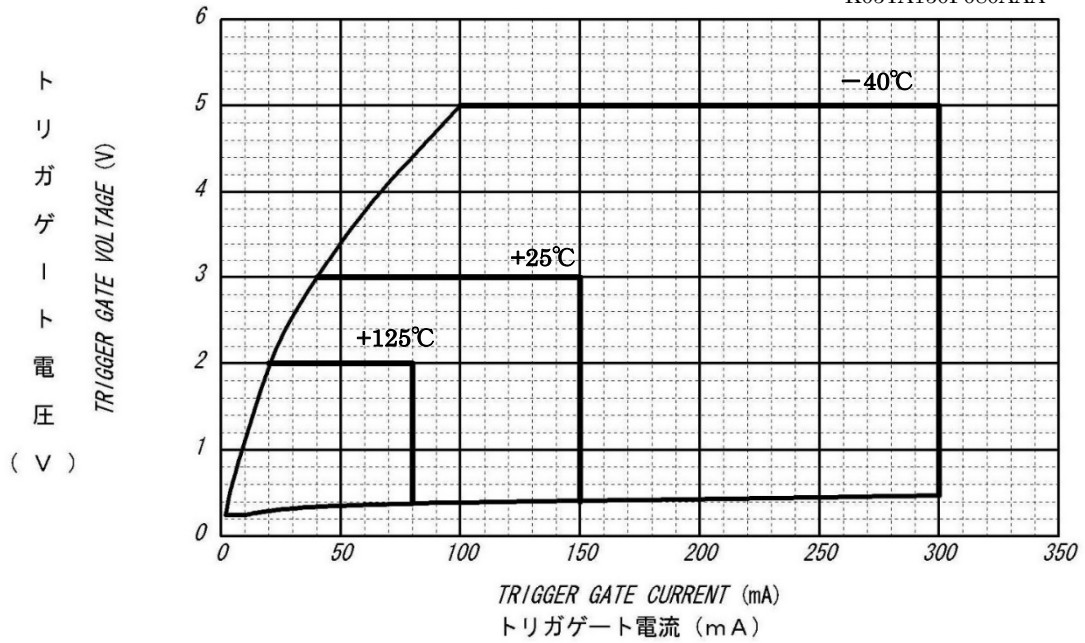

ゲート定格  
GATE RATINGS

K05TA150P080AAA

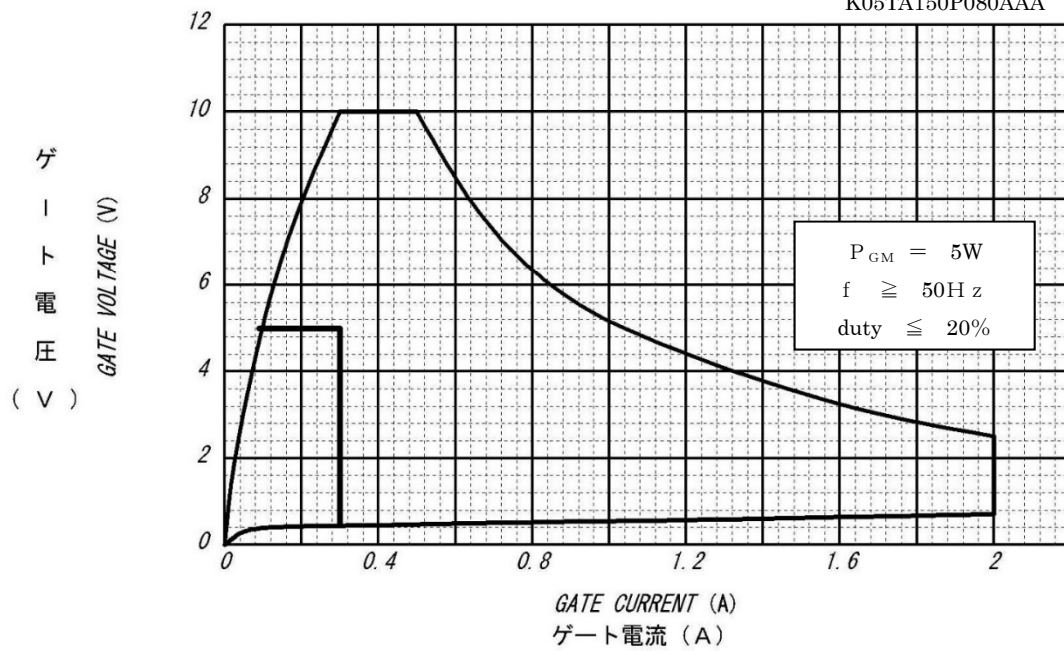

サージオン電流定格  
SURGE CURRENT RATINGS

f=50Hz, Half Sine Wave, Non-Repetitive, On Load

K05TA150P080AAA Per 1 Arm.

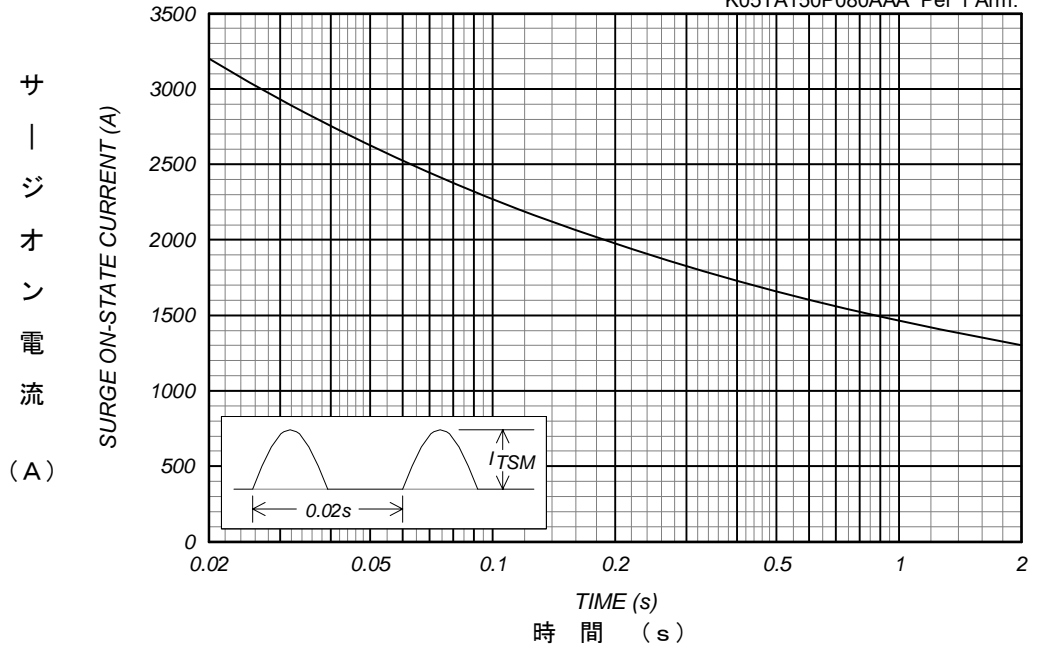

過渡熱抵抗特性  
Transient Thermal Impedance

K05TA150P080AAA Per 1 Arm.

